

# Imperial 2.6



01.11.2023 - bis auf Widerruf

# Imperial 2.6

MONTIERT



## Schwebetürenschränke

Fronten mit 6 Leisten: Dekor, Dekor mit Spiegel, Spiegel, Farbglas, Farbglas mit Spiegel

Breiten: 151, 201, 225, 250, 300, 350 cm

Höhen: 197, 223, 235 cm

Griffleisten: korpusfarben

Optional: Schränke mit oder ohne Beleuchtung.

Ausstattung je Schrankelement:

Höhe 197 cm: 1 Fachboden und 1 Kleiderstange.

Höhe 223 + 235 cm: 2 Fachböden und 1 Kleiderstange



Passende Extras  
finden Sie nach  
den Schränken.

## Korpusfarben:



Dekor-Druck  
Eiche Sonoma



Dekor-Druck  
Eiche Artisan



Dekor-Druck Eiche  
Sanremo hell



alpinweiß



seidengrau

## Frontfarben:

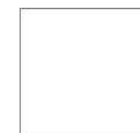

alpinweiß



seidengrau



Farbglas kristall-  
weiß



Farbglas seidengrau



Ganz einfach planbar mit:

**furn plan**

Lieferant: Rauch Möbelwerke GmbH

# Qualitätsmerkmale

**MONTIERT**



Innenfarbe  
Dekor-  
Druck Tex-  
line

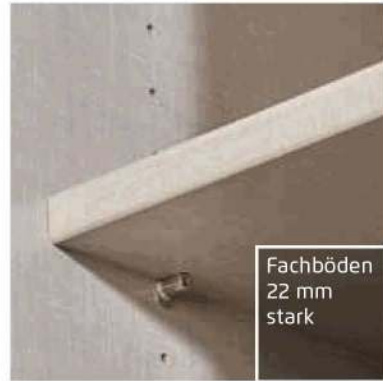

Fachböden  
22 mm  
stark



SOFT  
CLOSE

Schwebetü-  
rendämpfer  
optional



**MADE IN GERMANY**  
MÖBEL • FURNITURE  
Hersteller-Nr. / manufacture-no.  
H20090125  
Programm / program / Modell / model  
rauch ORANGE

Zertifiziert durch die DGM  
Verband der Deutschen Möbelindustrie e.V.

**RAL**

Die neue  
Herkunfts-  
gewähr beim  
Möbelkauf.



Extras siehe  
MONTIERT  
ZUBEHÖR 2.0

zeitlose  
Optik

attraktive  
Frontge-  
staltungen

langlebige  
Produkt-  
qualität

ausgezeich-  
nete Möbel-  
beschläge

umfan-  
greiches  
Zubehör

### Qualität und Material

**10 Jahre Garantie**

**10 Jahre Herstellergarantie!**  
Die Garantiebedingungen finden Sie auf [garantie](#) und in Hinweisen, die dem Produkt beiliegen.

**Dekor-Druck**  
Die Möbelteile mit Dekor-Druck haben eine gleichmäßig schöne, strapazierfähige Oberfläche.

**Belastbarkeit**  
Die Belastungsgrenzen für alle Möbel- und Zubehörteile finden Sie in der „Belastungstabelle“ unter:

**WOODMAX**  
Der wohngesunde  
Frischholz-Produkt

**WOODMAX Spanplatten**  
Die wohngesunde Frischholz-Spanplatte, speziell für die Verwendung in Wohnräumen, mit dem Prädikat „Schadstoffarm“. Für unsere Woodmax-Spanplatte verwenden wir nur unbelastete Schwach- und Bruchhölzer aus nachhaltigem Forstbetrieb regionaler Wälder.

**Unser Rohstoff aus der Natur**  
Für seinen Plattenwerkstoff erhielt verschiedene Auszeichnungen. Strenge Prüfungen von neutralen Instituten bestätigen kontinuierlich die Unbedenklichkeit von Material und Verfahren.

### Ausgezeichnet und zertifiziert

sustainability assured

100%  
made in  
Germany

10  
years  
warranty













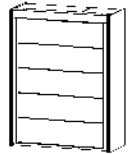
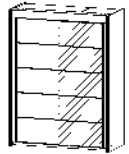
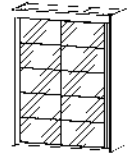
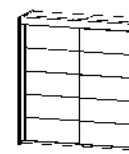

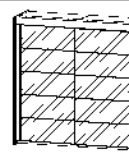
# Imperial 2.6

MONTIERT

1	MOD.-NR.	FRONTAUSFÜHRUNG ▶	DEKOR		FARBGLAS	
	Korpusfarbe ▼		alpinweiß	seidengrau	kristallweiß	seidengrau
	Dekor-Druck Eiche Sonoma	A6W06	A6W16	A6W16	A6W86	A6W96
	Dekor-Druck Eiche Artisan	A5W06	A5W16	A5W16	A5W86	A5W96
	Dekor-Druck Eiche Sanremo hell	A4W06	A4W16	A4W16	A4W86	A4W96
	alpinweiß	A8W06	A8W16	A8W16	A8W86	A8W96
	seidengrau	A1W06	A1W16	A1W16	A1W86	A1W96

2	Griffeleisten ▶	KORPUSFARBEN					
---	-----------------	--------------	--	--	--	--	--

3	Breite in cm	151	151	151	201	201	201
<b>SCHWEBETÜREN-SCHRÄNKE</b>  schraffierte Fläche = Spiegel	Tiefe 65 cm						
	Skizze						
	Beschreibung	2-türig	2-türig, 1 Spiegeltüre	2-türig, 2 Spiegeltüren	2-türig	2-türig, 1 Spiegeltüre	2-türig, 2 Spiegeltüren
	Korpus-Einteilung (cm)	100 50	100 50	100 50	100 100	100 100	100 100
HÖHE 197 CM		▼ Art.-Nr. ▼ Preis ...			HÖHE 197 CM		
Dekor	ohne Beleuchtung	<b>3I01</b>	<b>2I01</b>	<b>2I02</b>	<b>3I05</b>	<b>2I05</b>	<b>2I06</b>
	mit Beleuchtung 	<b>3L21</b>	<b>2L33</b>	<b>27L1</b>	<b>3L22</b>	<b>2L34</b>	<b>27L2</b>
Farbglas	ohne Beleuchtung	<b>21G1</b>	<b>2251</b>	-	<b>21G2</b>	<b>2252</b>	-
	mit Beleuchtung 	<b>2L51</b>	<b>25L0</b>	-	<b>2L52</b>	<b>25L1</b>	-
HÖHE 223 CM		▼ Art.-Nr. ▼ Preis ...			HÖHE 223 CM		
Dekor	ohne Beleuchtung	<b>4I01</b>	<b>5I01</b>	<b>5I02</b>	<b>4I05</b>	<b>5I05</b>	<b>5I06</b>
	mit Beleuchtung 	<b>4L21</b>	<b>5L33</b>	<b>59LA</b>	<b>4L22</b>	<b>5L34</b>	<b>59LB</b>
Farbglas	ohne Beleuchtung	<b>58G1</b>	<b>524A</b>	-	<b>58G2</b>	<b>524B</b>	-
	mit Beleuchtung 	<b>5L51</b>	<b>56L0</b>	-	<b>5L52</b>	<b>56L1</b>	-
HÖHE 235 CM		▼ Art.-Nr. ▼ Preis ...			HÖHE 235 CM		
Dekor	ohne Beleuchtung	<b>1I01</b>	<b>1I21</b>	<b>1I22</b>	<b>1I05</b>	<b>1I25</b>	<b>1I26</b>
	mit Beleuchtung 	<b>1L21</b>	<b>1L33</b>	<b>16L1</b>	<b>1L22</b>	<b>1L34</b>	<b>16L2</b>
Farbglas	ohne Beleuchtung	<b>13G1</b>	<b>1351</b>	-	<b>13G2</b>	<b>1352</b>	-
	mit Beleuchtung 	<b>1L51</b>	<b>14L0</b>	-	<b>1L52</b>	<b>14L1</b>	-

Weitere Breiten auf der nächsten Seite.

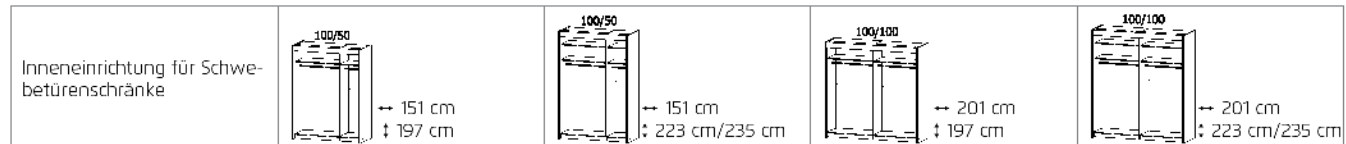
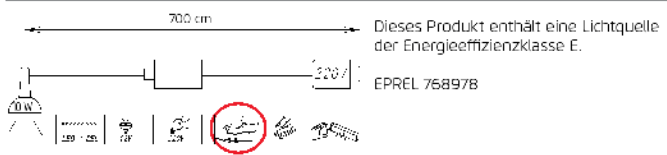





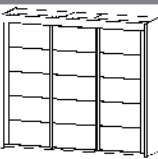
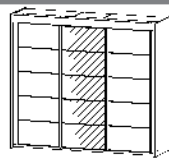
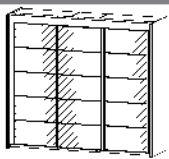
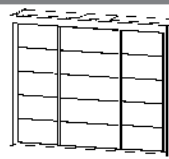
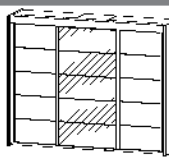
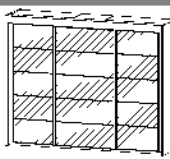

# Imperial 2.6

## MONTIERT

1	MOD.-NR.	FRONTAUSFÜHRUNG ▶	DEKOR		FARBGLAS	
	Korpusfarbe ▼		alpinweiß	seidengrau	kristallweiß	seidengrau
	Dekor-Druck Eiche Sonoma	<b>A6W06</b>	<b>A6W16</b>	<b>A6W86</b>	<b>A6W96</b>	<b>A6W96</b>
	Dekor-Druck Eiche Artisan	<b>A5W06</b>	<b>A5W16</b>	<b>A5W86</b>	<b>A5W96</b>	<b>A5W96</b>
	Dekor-Druck Eiche Sanremo hell	A4W06	A4W16	A4W86	A4W96	A4W96
	alpinweiß	<b>A8W06</b>	<b>A8W16</b>	<b>A8W86</b>	<b>A8W96</b>	<b>A8W96</b>
	seidengrau	A1W06	A1W16	A1W86	A1W96	A1W96

2	Griffleisten ▶	KORPUSFARBEN					
---	----------------	--------------	--	--	--	--	--

3	Breite in cm	225	225	225	250	250	250
<b>SCHWEBETÜREN-SCHRÄNKE</b>  schraffierte Fläche = Spiegel	Tiefe 65 cm						
	Beschreibung	3-türig	3-türig, 1 Spiegeltür	3-türig, 3 Spiegeltüren	3-türig	3-türig, 1 Spiegeltür	3-türig, 3 Spiegeltüren
	Korpus-Einteilung (cm)	90 45 90	90 45 90	90 45 90	100 50 100	100 50 100	100 50 100
HÖHE 197 CM		▼ Art.-Nr. ▼ Preis ...			HÖHE 197 CM		
Dekor	ohne Beleuchtung	<b>3107</b>	<b>2107</b>	<b>2108</b>	<b>3109</b>	<b>2109</b>	<b>2110</b>
	mit Beleuchtung 	<b>3L23</b>	<b>2L35</b>	<b>27L3</b>	<b>3L24</b>	<b>2L36</b>	<b>27L4</b>
Farbglas	ohne Beleuchtung	<b>21G3</b>	<b>2253</b>	-	<b>21G4</b>	<b>2254</b>	-
	mit Beleuchtung 	<b>2L53</b>	<b>25L2</b>	-	<b>2L54</b>	<b>25L3</b>	-
HÖHE 223 CM		▼ Art.-Nr. ▼ Preis ...			HÖHE 223 CM		
Dekor	ohne Beleuchtung	<b>4107</b>	<b>5107</b>	<b>5108</b>	<b>4109</b>	<b>5109</b>	<b>5110</b>
	mit Beleuchtung 	<b>4L23</b>	<b>5L35</b>	<b>59LC</b>	<b>4L24</b>	<b>5L36</b>	<b>59LD</b>
Farbglas	ohne Beleuchtung	<b>58G3</b>	<b>524C</b>	-	<b>58G4</b>	<b>524D</b>	-
	mit Beleuchtung 	<b>5L53</b>	<b>56L2</b>	-	<b>5L54</b>	<b>56L3</b>	-
HÖHE 235 CM		▼ Art.-Nr. ▼ Preis ...			HÖHE 235 CM		
Dekor	ohne Beleuchtung	<b>1107</b>	<b>1127</b>	<b>1128</b>	<b>1109</b>	<b>1129</b>	<b>1130</b>
	mit Beleuchtung 	<b>1L23</b>	<b>1L35</b>	<b>16L3</b>	<b>1L24</b>	<b>1L36</b>	<b>16L4</b>
Farbglas	ohne Beleuchtung	<b>13G3</b>	<b>1353</b>	-	<b>13G4</b>	<b>1354</b>	-
	mit Beleuchtung 	<b>1L53</b>	<b>14L2</b>	-	<b>1L54</b>	<b>14L3</b>	-

Weitere Breiten auf der nächsten Seite.

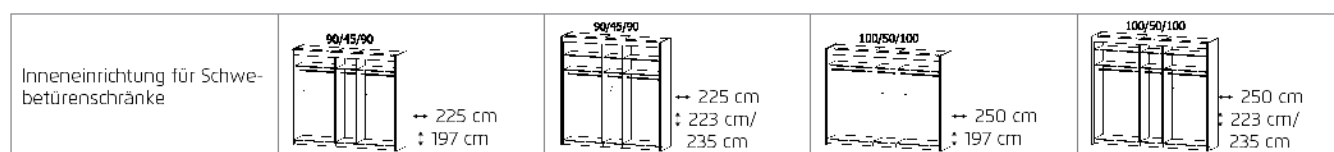
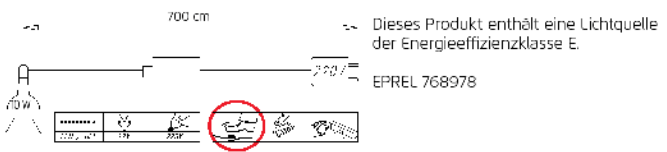





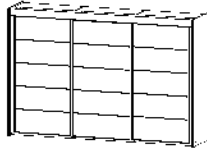
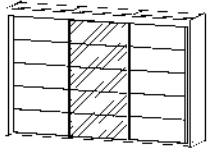
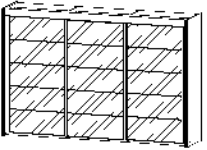
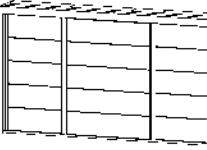
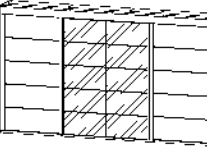
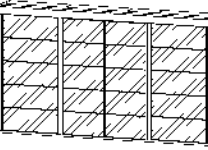

# Imperial 2.6

MONTIERT

1 MOD.-NR.	FRONTAUSFÜHRUNG ▶	DEKOR		FARBGLAS	
Korpusfarbe ▼		alpinweiß	seidengrau	kristallweiß	seidengrau
Dekor-Druck Eiche Sonoma	A6W06	A6W16		A6W86	A6W96
Dekor-Druck Eiche Artisan	A5W06	A5W16		A5W86	A5W96
Dekor-Druck Eiche Sanremo hell	A4W06	A4W16		A4W86	A4W96
alpinweiß	A8W06	A8W16		A8W86	A8W96
seidengrau	A1W06	A1W16		A1W86	A1W96

2 Griffleisten ▶ KORPUSFARBEN

3 SCHWEBETÜREN-SCHRÄNKE	Breite in cm	300		300		300		350		350		350	
		Tiefe 65 cm		Tiefe 65 cm		Tiefe 65 cm		Tiefe 65 cm		Tiefe 65 cm		Tiefe 65 cm	
 schraffierte Fläche = Spiegel	Skizze												
	Beschreibung	3-türig		3-türig, 1 Spiegeltüre		3-türig, 3 Spiegeltüren		4-türig		4-türig, 2 Spiegeltüren		4-türig, 4 Spiegeltüren	
	Korpus-Einteilung (cm)	100 100 100		100 100 100		100 100 100		100 100 50 100		100 100 50 100		100 100 50 100	
HÖHE 197 CM		▼ Art.-Nr.	▼ Preis	...	...	HÖHE 197 CM							
Dekor	ohne Beleuchtung	<b>3I13</b>		<b>2I13</b>		<b>2I14</b>		<b>3I17</b>		<b>2I17</b>		<b>2I18</b>	
	mit Beleuchtung 	<b>3L25</b>		<b>2L37</b>		<b>27L5</b>		<b>3L26</b>		<b>2L38</b>		<b>27L6</b>	
Farbglas	ohne Beleuchtung	<b>2IG5</b>		<b>2255</b>		-	-	<b>2IG7</b>		<b>2256</b>		-	-
	mit Beleuchtung 	<b>2LG5</b>		<b>25L4</b>		-	-	<b>2LG6</b>		<b>25L5</b>		-	-
HÖHE 223 CM		▼ Art.-Nr.	▼ Preis	...	...	HÖHE 223 CM							
Dekor	ohne Beleuchtung	<b>4I13</b>		<b>5I13</b>		<b>5I14</b>		<b>4I17</b>		<b>5I17</b>		<b>5I18</b>	
	mit Beleuchtung 	<b>4L25</b>		<b>5L37</b>		<b>59LF</b>		<b>4L26</b>		<b>5L38</b>		<b>59LJ</b>	
Farbglas	ohne Beleuchtung	<b>58G5</b>		<b>524F</b>		-	-	<b>58G7</b>		<b>524J</b>		-	-
	mit Beleuchtung 	<b>5LG5</b>		<b>56L4</b>		-	-	<b>5LG6</b>		<b>56L5</b>		-	-
HÖHE 235 CM		▼ Art.-Nr.	▼ Preis	...	...	HÖHE 235 CM							
Dekor	ohne Beleuchtung	<b>1I13</b>		<b>1I33</b>		<b>1I34</b>		<b>1I17</b>		<b>1I37</b>		<b>1I38</b>	
	mit Beleuchtung 	<b>1L25</b>		<b>1L37</b>		<b>16L5</b>		<b>1L26</b>		<b>1L38</b>		<b>16L6</b>	
Farbglas	ohne Beleuchtung	<b>13G5</b>		<b>1355</b>		-	-	<b>13G7</b>		<b>1356</b>		-	-
	mit Beleuchtung 	<b>1LG5</b>		<b>14L4</b>		-	-	<b>1LG6</b>		<b>14L5</b>		-	-

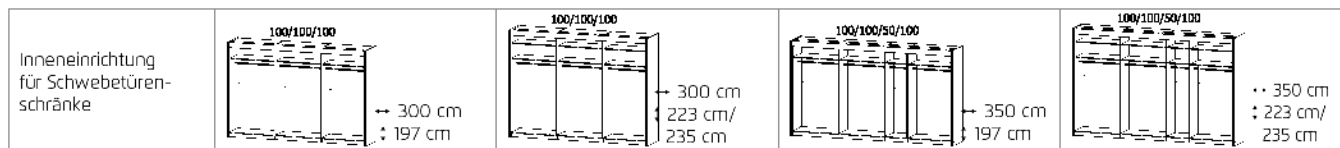
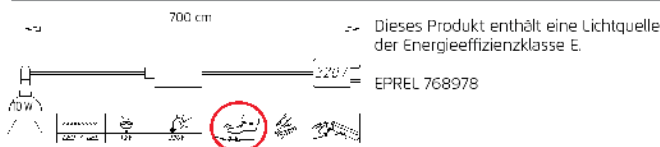

# Imperial 2.6

**MONTIERT**

# ZUBEHÖR 2.0

**MONTIERT**

für Imperial-Schwebetürenschränke  
Elementbreite 45, 50, 90, 100 cm



Farbe	Modell-Nr.
Texline (naturfarbene Leinenoptik)	A0032



Texline

Lieferant: Rauch Möbelwerke GmbH



# ZUBEHÖR 2.0

## MONTIERT

für Imperial-Schwebetürenschränke

Elementbreite 45, 50, 90, 100 cm

Diese Schrankbreiten bestehen aus folgenden Elementen:



		Höhe 197 cm	Höhe 223, 235 cm			Höhe 197 cm	Höhe 223, 235 cm
↔ 150 cm				↔ 280 cm*			
↔ 181 cm*				↔ 300 cm			
↔ 200 cm				↔ 320 cm*			
↔ 225 cm				↔ 350 cm			
↔ 250 cm				* nicht erhältlich für Imperial 2.0/2.3/2.6			



# ZUBEHÖR 2.0

## MONTIERT

für Imperial-Schwebetürenschränke  
Elementbreite **45, 50, 90, 100 cm**

Farbe	Modell-Nr.
Texline (naturfarbene Leinenoptik)	A0032

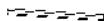
ELEMENTBREITE ▶		45	45	45
				
		<b>Fachböden</b>	<b>Kleiderstange</b>	<b>Schubkasteneinsatz</b>
		für Elementbreite 45cm	für Elementbreite 45cm	für Elementbreite 45cm
		↔43 cm ↑2 cm ↘46 cm	↔43 cm ↑3 cm ↘2 cm	↔43 cm ↑63 cm ↘46 cm
1 Stück	Preis	<b>9424</b>	<b>9737</b>	<b>98BA</b>
3er Set		<b>9414</b>		

ELEMENTBREITE ▶		50	50	50
				
		<b>Fachböden</b>	<b>Kleiderstange</b>	<b>Schubkasteneinsatz</b>
		für Elementbreite 50 cm	für Elementbreite 50 cm	für Elementbreite 50 cm mit 3 Schubkästen
		↔48 cm ↑2 cm ↘46 cm	↔48 cm ↑3 cm ↘2 cm	↔48 cm ↑63 cm ↘46 cm
1 Stück	Preis	<b>9423</b>	<b>9739</b>	<b>98BB</b>
3er Set		<b>9413</b>		

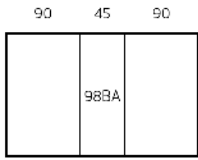
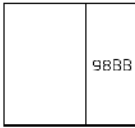
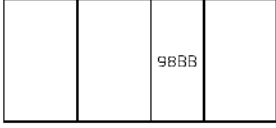
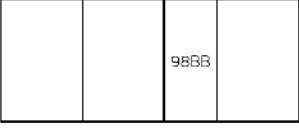
	45	50	50	50
EINBAUMÖGLICHKEITEN FÜR SCHUBKASTENEINSÄTZE	 <p>Schwebetürenschränk B 225 cm, 3-trg.</p>	 <p>Schwebetürenschränk B 150 cm, 2-trg.</p>	 <p>Schwebetürenschränk B 320 cm, 4-trg.</p>	 <p>Schwebetürenschränk B 350 cm, 4-trg.</p>



# ZUBEHÖR 2.0

## MONTIERT

für Imperial-Schwebetürenschränke

Elementbreite 45, 50, **90**, 100 cm

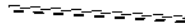
Farbe	Modell-Nr.
Texline (naturfarbene Leinenoptik)	A0032

ELEMENTBREITE ▶		90	90	90
				
		<b>Fachböden</b> für Elementbreite 90cm ••88 cm ↑2 cm ↘46 cm	<b>Kleiderstange</b> für Elementbreite 90cm ••87 cm ↑3 cm ↘2 cm	<b>Schrankinneneinteilung</b> mit Kleiderstange mit 3 Fachböden für Elementbreite 90cm ••88 cm ↑147 cm ↘49 cm
1 Stück	Preis	<b>9422</b>	<b>9736</b>	<b>999V</b>
3er Set		<b>9412</b>		

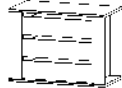
ELEMENTBREITE ▶		90	90
nicht erhältlich für Imperial 2.0/2.3/2.6			
		<b>Kleiderlift</b> für Elementbreite 90cm ••98 cm ↑84 cm ↘14 cm	<b>Schubkasteneinsatz</b> für Elementbreite 90cm ••88 cm ↑63 cm ↘46 cm
Artikel	Preis	<b>9314</b>	<b>98BD</b>

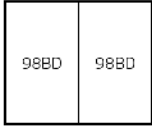
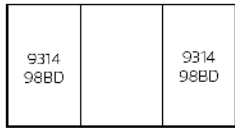
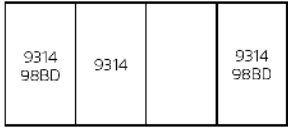



	90	90	90	90	90	90	50	90	
<b>EINBAUMÖGLICHKEITEN FÜR SCHUBKASTENEINSÄTZE UND KLEIDERLIFT</b>									
	Schwebetürenschränk B 180 cm, 2-trg.		Schwebetürenschränk B 280 cm, 3-trg.			Schwebetürenschränk B 320 cm, 4-trg.			

# ZUBEHÖR 2.0



## MONTIERT

für Imperial-Schwebetürenschränke  
Elementbreite 45, 50, 90, **100** cm

Farbe	Modell-Nr.
Texline (naturfarbene Leinenoptik)	A0032

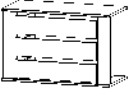
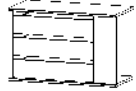
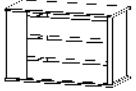
ELEMENTBREITE ▶		100	100	100	100
					
		<b>Fachböden</b> für Elementbreite 100cm ••98 cm †2 cm ‹46 cm	<b>Kleiderstange</b> für Elementbreite 100cm ••100 cm †3 cm ‹2 cm	<b>Schränkinneneinteilung</b> mit Kleiderstange mit 3 Fachböden für Elementbreite 100cm ••98 cm †147 cm ‹49 cm	<b>Kleiderlift</b> ••98 cm †84 cm ‹14 cm
1 Stück	Preis	<b>9421</b>	<b>9758</b>	<b>999U</b>	<b>9314</b>
3er Set		<b>9411</b>			

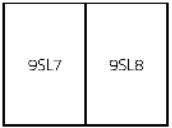
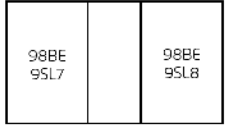
ELEMENTBREITE ▶		100	100	100
				
		<b>Schubkasteneinsatz</b> für Elementbreite 100cm mit 3 Schubkästen ••98 cm †63 cm ‹46 cm	<b>Schubkasteneinsatz</b> für Elementbreite 100cm mit 3 Schubkästen ••98 cm †63 cm ‹46 cm	<b>Schubkasteneinsatz</b> für Elementbreite 100cm mit 3 Schubkästen ••98 cm †63 cm ‹46 cm
Artikel	Preis	<b>98BE</b>	<b>9SL7</b>	<b>9SL8</b>

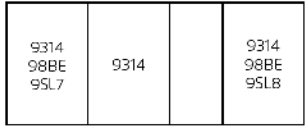

	100	100	100	100	100	100	100	50	100			
EINBAUMÖGLICH- KEITEN FÜR SCHUB- KASTENEINSÄTZE UND KLEIDERLIFT												
	Schwebetürenschränk B 200 cm, 2-trg.		Schwebetürenschränk B 250 cm, 3-trg.			Schwebetürenschränk B 300 cm, 3-trg.			Schwebetürenschränk B 350 cm, 4-trg.			



# ZUBEHÖR 2.0

## MONTIERT

für Imperial-Schwebetürenschränke  
Allgemein

Farbe	Modell-Nr.
Texline (naturfarbene Leinenoptik)	A0032

ALLGEMEIN				
				
		Kleiderbügelhalter	Krawatten-/Gürtelhalter	Hosenhalter
		••31 cm •6 cm √4 cm	••10 cm •13 cm √46 cm	••25 cm •7 cm √46 cm
Artikel	Preis	<b>9760</b>	<b>990K</b>	<b>990H</b>

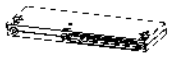
ALLGEMEIN				
				
		Hakenleiste	Garderobenhalter	Schwebetürendämpfer 2er Set
		••35 cm •5 cm √5 cm	••7 cm •52 cm √28 cm	••2 cm •7 cm √27 cm
Artikel	Preis	<b>9HL1</b>	<b>9767</b>	<b>9TD2</b>