

# Cardiff



**07.03.2024 - bis auf Widerruf**

# Cardiff

gültig ab 07.03.2024



Emissionsgeprüft  
Schadstoffgeprüft  
Regelmäßige  
Produkt-  
überwachung

www.tuv.com  
ID 1111253053





# Cardiff

gültig ab 07.03.2024



Eiche teilmassiv,  
wenige Äste



Emissionsgeprüft  
Schadstoffgeprüft  
Regelmäßige  
Produkt-  
überwachung

www.tuv.com  
ID 1111253053





# Cardiff

gültig ab 07.03.2024

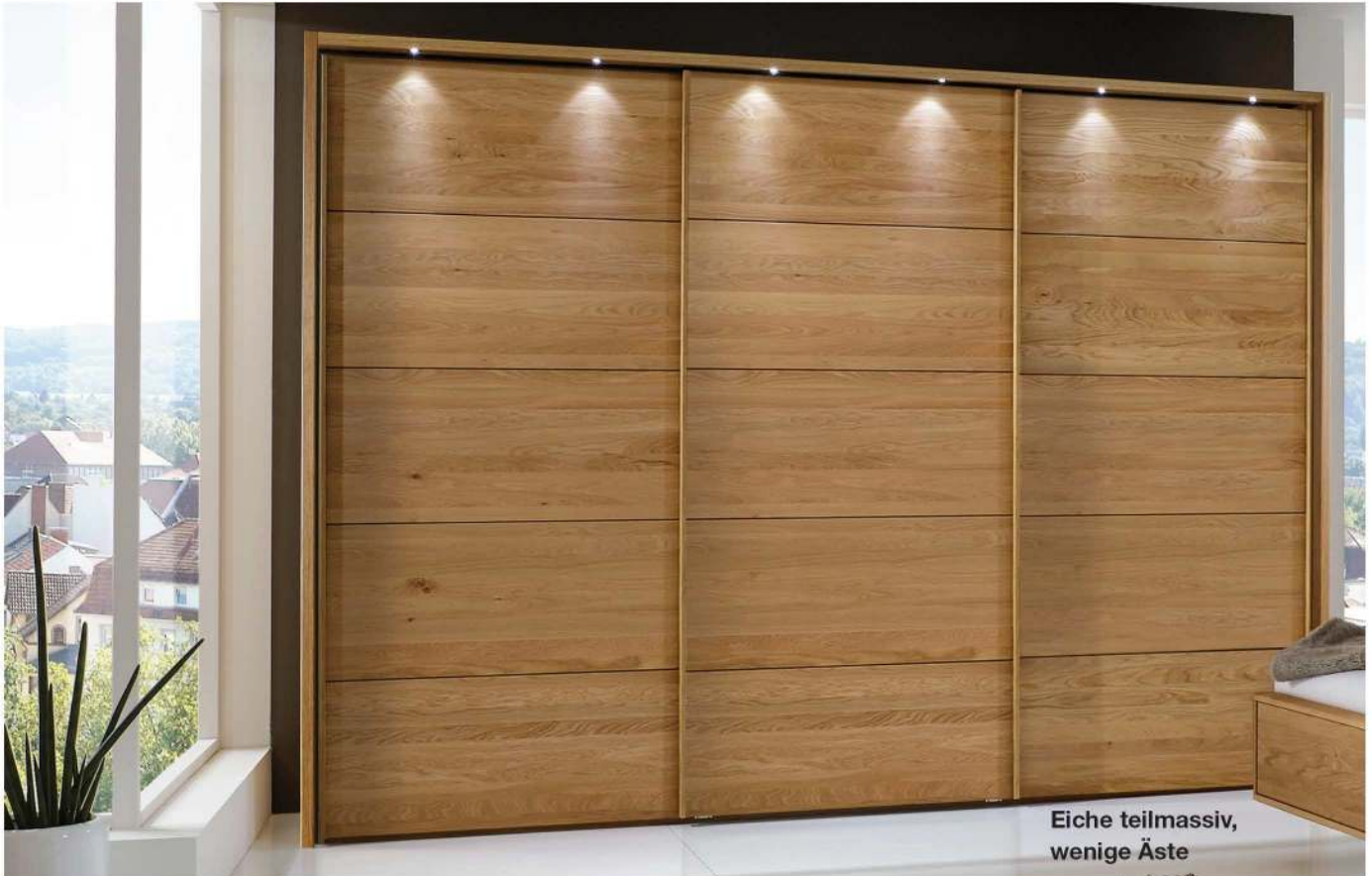

Emissionsgeprüft  
Schadstoffgeprüft  
Regelmäßige  
Produkt-  
überwachung

www.tuv.com  
ID 1111253053





# Cardiff

gültig ab 07.03.2024



Emissionsgeprüft  
Schadstoffgeprüft  
Regelmäßige  
Produkt-  
überwachung  
[www.tuv.com](http://www.tuv.com)  
ID 1111253053





# Cardiff

gültig ab 07.03.2024



Emissionsgeprüft  
Schadstoffgeprüft  
Regelmäßige  
Produkt-  
überwachung

www.tuv.com  
ID 1111253053



# Cardiff

gültig ab 07.03.2024

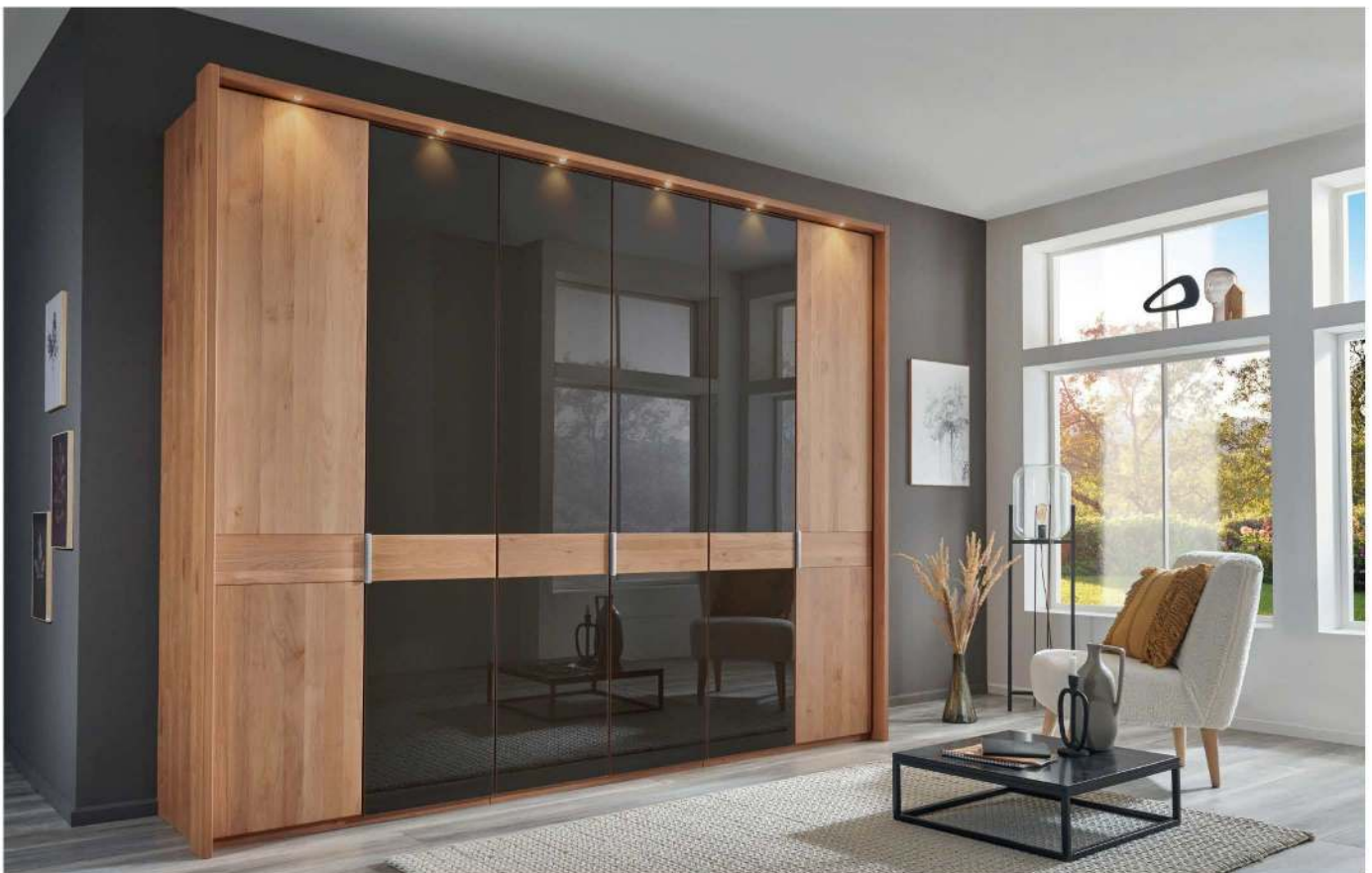

Emissionsgeprüft  
Schadstoffgeprüft  
Regelmäßige  
Produkte-  
überwachung  
[www.tuv.com](http://www.tuv.com)  
ID 1111253053





# Cardiff

gültig ab 07.03.2024



Emissionsgeprüft  
Schadstoffgeprüft  
Regelmäßige  
Produkt-  
überwachung  
[www.tuv.com](http://www.tuv.com)  
ID 1111253053





# Cardiff

gültig ab 07.03.2024







Emissionsgeprüft  
Schadstoffgeprüft  
Regelmäßige  
Produkt-  
überwachung  
www.tuv.com  
ID 1111253053



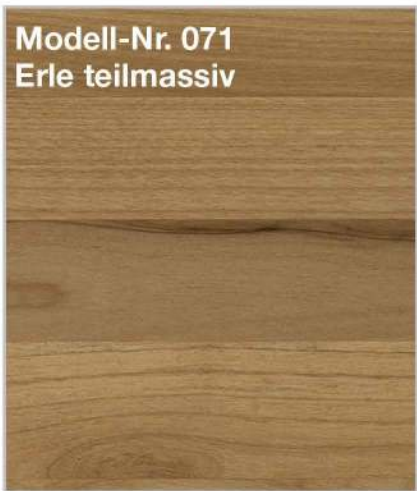

## LIEFERBARE KORPUS- UND FRONTAUSFÜHRUNGEN

Bitte geben Sie bei jeder Bestellung die exakte Farbkombination aus Front- und Korpusfarbe an!

### Farbausführungen:

Preisgruppe 1 (PG1)	Preisgruppe 2 (PG2)	Preisgruppe 3 (PG3)
		
<p><b>Modell-Nr. 071</b> Erle teilmassiv</p> 	<p><b>Modell-Nr. 079</b> Eiche teilmassiv wenige Äste</p> 	<p><b>Modell-Nr. 094</b> Bianco-Eiche teilmassiv mit Ästen</p> 

### Glasfronten

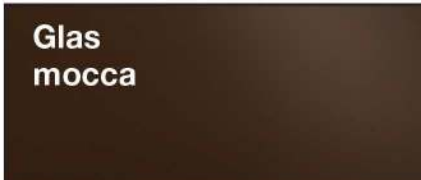
<p><b>Glas weiß</b></p> 	<p><b>Glas Champagner</b></p> 	<p><b>Glas mocca</b></p> 
---	---	--

### Spiegel



### Innenfarbton



**furn plan**





## Korpusbreiten

### Drehtürenschränke

Breite	Seite	Sockel	Seite	Sockel	Seite	Sockel	Seite	Sockel	Seite	Sockel	Breite effektiv
50	1,5	47,5	1,5								50,5 cm
100	1,5	96,4	1,5								99,4 cm
150	1,5	96,4	1,5	47,5	1,5						148,4 cm
200	1,5	96,4	1,5	96,4	1,5						197,3 cm
250	1,5	96,4	1,5	47,5	1,5	96,4	1,5				246,3 cm
300	1,5	96,4	1,5	96,4	1,5	96,4	1,5				295,2 cm
350	1,5	96,4	1,5	96,4	1,5	47,5	1,5	96,4	1,5		344,2 cm
400	1,5	96,4	1,5	96,4	1,5	96,4	1,5	96,4	1,5		393,1 cm

### Schwebetürenschränke

Breite	Seite	Sockel	Seite	Sockel	Seite	Sockel	Seite	Sockel	Seite	Breite effektiv
150	1,5	72,2	1,5	72,2	1,5					148,9 cm
200	1,5	96,4	1,5	96,4	1,5					197,3 cm
225	1,5	72,2	1,5	72,2	1,5	72,2	1,5			222,6 cm
250	1,5	80,1	1,5	80,1	1,5	80,1	1,5			246,3 cm
300	1,5	96,4	1,5	96,4	1,5	96,4	1,5			295,2 cm
300	1,5	72,2	1,5	72,2	1,5	72,2	1,5	72,2	1,5	296,3 cm
330	1,5	80,1	1,5	80,1	1,5	80,1	1,5	80,1	1,5	327,9 cm
400	1,5	96,4	1,5	96,4	1,5	96,4	1,5	96,4	1,5	393,1 cm

## QUALITÄT IM DETAIL

- Schwebetürenschränke und Drehtürenschränke mit **Fronten in Massivholz oder in Kombination** mit Glas oder Spiegel
- **2 Schrankhöhen**
- Rückwände: Hartfaser, eingenetet, je Schrankfach **4 Rückwandhalter** aus Metall
- Einlegeböden: 22 mm stark, auf Metallbodenträgern, 20 kg belastbar
- Metall-Kleiderstangen in Metallhalterungen, **40 kg belastbar**
- Alle Beschläge sind aus Metall und hoch belastbar
- Komfort-Betten mit Polster- und Holzkopfteil in 7 Breiten und 4 Längen
- Umfangreiches Kommodenprogramm
- LED-Beleuchtung auf Wunsch



## Drehtürenschränke



ohne Kranzleiste

Tiefe: 58 cm

### Innenausstattung:

2 Einlegeböden, 1 Kleiderstange je Fach

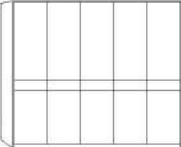
Alle Drehtüren inkl. gedämpfter Scharniere

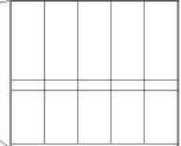
Beschreibung	Breite in cm	Höhe 216 cm			Höhe 236 cm				
		Art.-Nr.	PG 1 EURO	PG 2 EURO	PG 3 EURO	Art.-Nr.	PG 1 EURO	PG 2 EURO	PG 3 EURO
 <p><b>mit Griffen in chrom</b></p>									
 <p><b>Holztüren mit Querriegel in massiv</b></p>									
<p>1-türig links angeschlagen</p> <p>1-türig rechts angeschlagen</p> <p>2-türig</p> <p>3-türig</p> <p>4-türig</p> <p>5-türig</p> <p>6-türig</p> <p>7-türig</p> <p>8-türig</p>	<p>50</p> <p>50</p> <p>100</p> <p>150</p> <p>200</p> <p>250</p> <p>300</p> <p>350</p> <p>400</p>	<p><b>A01</b></p> <p><b>A02</b></p> <p><b>A03</b></p> <p><b>A04</b></p> <p><b>A05</b></p> <p><b>A06</b></p> <p><b>A07</b></p> <p><b>A08</b></p> <p><b>A09</b></p>				<p><b>A19</b></p> <p><b>A20</b></p> <p><b>A21</b></p> <p><b>A22</b></p> <p><b>A23</b></p> <p><b>A24</b></p> <p><b>A25</b></p> <p><b>A26</b></p> <p><b>A27</b></p>			
<p>Art.-Nr. A06/ A24</p>									
 <p><b>mit Griffen in Schiefer</b></p>									
 <p><b>Holztüren mit Querriegel in massiv</b></p>									
<p>1-türig links angeschlagen</p> <p>1-türig rechts angeschlagen</p> <p>2-türig</p> <p>3-türig</p> <p>4-türig</p> <p>5-türig</p> <p>6-türig</p> <p>7-türig</p> <p>8-türig</p>	<p>50</p> <p>50</p> <p>100</p> <p>150</p> <p>200</p> <p>250</p> <p>300</p> <p>350</p> <p>400</p>	<p><b>A10</b></p> <p><b>A11</b></p> <p><b>A12</b></p> <p><b>A13</b></p> <p><b>A14</b></p> <p><b>A15</b></p> <p><b>A16</b></p> <p><b>A17</b></p> <p><b>A18</b></p>				<p><b>A28</b></p> <p><b>A29</b></p> <p><b>A30</b></p> <p><b>A31</b></p> <p><b>A32</b></p> <p><b>A33</b></p> <p><b>A34</b></p> <p><b>A35</b></p> <p><b>A36</b></p>			
<p>Art.-Nr. A15/ A33</p>									



## Drehtürenschränke

ohne Kranzleiste

Tiefe: 58 cm

### Innenausstattung:

2 Einlegeböden, 1 Kleiderstange je Fach

Alle Drehtüren inkl. gedämpfter Scharniere

Beschreibung	Breite in cm	Höhe 216 cm			Höhe 236 cm				
		Art.-Nr.	PG 1 EURO	PG 2 EURO	PG 3 EURO	Art.-Nr.	PG 1 EURO	PG 2 EURO	PG 3 EURO
 <b>mit Griffen in chrom</b>									
 <b>Holztüren mit Spiegeltüren in Parsol-Bronze-Glas, Querriegel in massiv</b>									
Art.-Nr. A45 / A72									
1-türig 1 Spiegeltür, links ang.	50	<b>A37</b>				<b>A54</b>			
1-türig 1 Spiegeltür, rechts ang.	50	<b>A38</b>				<b>A55</b>			
2-türig 1 Spiegeltür, links ang.	100	<b>A39</b>				<b>A66</b>			
2-türig 1 Spiegeltür, rechts ang.	100	<b>A40</b>				<b>A67</b>			
2-türig 2 Spiegeltüren	100	<b>A41</b>				<b>A68</b>			
3-türig 1 Spiegeltür	150	<b>A42</b>				<b>A69</b>			
4-türig 2 Spiegeltüren	200	<b>A43</b>				<b>A70</b>			
5-türig 1 Spiegeltür	250	<b>A44</b>				<b>A71</b>			
5-türig 3 Spiegeltüren	250	<b>A45</b>				<b>A72</b>			
6-türig 2 Spiegeltüren	300	<b>A46</b>				<b>A73</b>			
6-türig 4 Spiegeltüren	300	<b>A47</b>				<b>A74</b>			
7-türig 1 Spiegeltür	350	<b>A48</b>				<b>A75</b>			
7-türig 3 Spiegeltüren	350	<b>A49</b>				<b>A76</b>			
7-türig 5 Spiegeltüren	350	<b>A50</b>				<b>A77</b>			
8-türig 2 Spiegeltüren	400	<b>A51</b>				<b>A78</b>			
8-türig 4 Spiegeltüren	400	<b>A52</b>				<b>A79</b>			
8-türig 6 Spiegeltüren	400	<b>A53</b>				<b>A80</b>			

## Drehtürenschränke

ohne Kranzleiste

Tiefe: 58 cm

### Innenausstattung:

2 Einlegeböden, 1 Kleiderstange je Fach

Alle Drehtüren inkl. gedämpfter Scharniere

Beschreibung	Breite in cm	Höhe 216 cm			Höhe 236 cm				
		Art.-Nr.	PG 1 EURO	PG 2 EURO	PG 3 EURO	Art.-Nr.	PG 1 EURO	PG 2 EURO	PG 3 EURO
 <b>mit Griffen in Schiefer</b>									
 <b>Holztüren mit Spiegeltüren in Parsol-Bronze-Glas, Querriegel in massiv</b>									
Art.-Nr. A89 / B07									
1-türig 1 Spiegeltür, links ang.	50	<b>A81</b>				<b>A98</b>			
1-türig 1 Spiegeltür, rechts ang.	50	<b>A82</b>				<b>A99</b>			
2-türig 1 Spiegeltür, links ang.	100	<b>A83</b>				<b>B01</b>			
2-türig 1 Spiegeltür, rechts ang.	100	<b>A84</b>				<b>B02</b>			
2-türig 2 Spiegeltüren	100	<b>A85</b>				<b>B03</b>			
3-türig 1 Spiegeltür	150	<b>A86</b>				<b>B04</b>			
4-türig 2 Spiegeltüren	200	<b>A87</b>				<b>B05</b>			
5-türig 1 Spiegeltür	250	<b>A88</b>				<b>B06</b>			
5-türig 3 Spiegeltüren	250	<b>A89</b>				<b>B07</b>			
6-türig 2 Spiegeltüren	300	<b>A90</b>				<b>B08</b>			
6-türig 4 Spiegeltüren	300	<b>A91</b>				<b>B09</b>			
7-türig 1 Spiegeltür	350	<b>A92</b>				<b>B10</b>			
7-türig 3 Spiegeltüren	350	<b>A93</b>				<b>B11</b>			
7-türig 5 Spiegeltüren	350	<b>A94</b>				<b>B12</b>			
8-türig 2 Spiegeltüren	400	<b>A95</b>				<b>B13</b>			
8-türig 4 Spiegeltüren	400	<b>A96</b>				<b>B14</b>			
8-türig 6 Spiegeltüren	400	<b>A97</b>				<b>B15</b>			



## Drehtürenschränke

ohne Kranzleiste

Tiefe: 58 cm

### Innenausstattung:

2 Einlegeböden, 1 Kleiderstange je Fach

Alle Drehtüren inkl. gedämpfter Scharniere

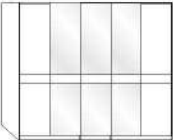
Beschreibung	Breite in cm	Höhe 216 cm			Höhe 236 cm				
		Art.-Nr.	PG 1 EURO	PG 2 EURO	PG 3 EURO	Art.-Nr.	PG 1 EURO	PG 2 EURO	PG 3 EURO
 <b>mit Griffen in chrom</b>									
 <b>Front in Glas weiß mit Querriegel in massiv, wahlweise Außentüren in Holz</b>									
Art.-Nr. B23 / B38									
1-türig	1 Glastür, links ang.	50	<b>B16</b>				<b>B31</b>		
1-türig	1 Glastür, rechts ang.	50	<b>B17</b>				<b>B32</b>		
2-türig	2 Glastüren	100	<b>B18</b>				<b>B33</b>		
3-türig	1 Glastür	150	<b>B19</b>				<b>B34</b>		
3-türig	3 Glastüren	150	<b>B20</b>				<b>B35</b>		
4-türig	2 Glastüren	200	<b>B21</b>				<b>B36</b>		
4-türig	4 Glastüren	200	<b>B22</b>				<b>B37</b>		
5-türig	3 Glastüren	250	<b>B23</b>				<b>B38</b>		
5-türig	5 Glastüren	250	<b>B24</b>				<b>B39</b>		
6-türig	4 Glastüren	300	<b>B25</b>				<b>B40</b>		
6-türig	6 Glastüren	300	<b>B26</b>				<b>B41</b>		
7-türig	5 Glastüren	350	<b>B27</b>				<b>B42</b>		
7-türig	7 Glastüren	350	<b>B28</b>				<b>B43</b>		
8-türig	6 Glastüren	400	<b>B29</b>				<b>B44</b>		
8-türig	8 Glastüren	400	<b>B30</b>				<b>B45</b>		

## Drehtürenschränke

ohne Kranzleiste

Tiefe: 58 cm

### Innenausstattung:

2 Einlegeböden, 1 Kleiderstange je Fach

Alle Drehtüren inkl. gedämpfter Scharniere

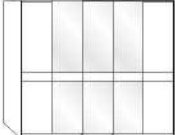
Beschreibung	Breite in cm	Höhe 216 cm			Höhe 236 cm				
		Art.-Nr.	PG 1 EURO	PG 2 EURO	PG 3 EURO	Art.-Nr.	PG 1 EURO	PG 2 EURO	PG 3 EURO
 mit Griffen in Schiefer									
 Front in Glas weiß mit Querriegel in massiv, wahlweise Außentüren in Holz									
Art.-Nr. B53 / B68									
1-türig	1 Glastür, links ang.	50	<b>B46</b>			<b>B61</b>			
1-türig	1 Glastür, rechts ang.	50	<b>B47</b>			<b>B62</b>			
2-türig	2 Glastüren	100	<b>B48</b>			<b>B63</b>			
3-türig	1 Glastür	150	<b>B49</b>			<b>B64</b>			
3-türig	3 Glastüren	150	<b>B50</b>			<b>B65</b>			
4-türig	2 Glastüren	200	<b>B51</b>			<b>B66</b>			
4-türig	4 Glastüren	200	<b>B52</b>			<b>B67</b>			
5-türig	3 Glastüren	250	<b>B53</b>			<b>B68</b>			
5-türig	5 Glastüren	250	<b>B54</b>			<b>B69</b>			
6-türig	4 Glastüren	300	<b>B55</b>			<b>B70</b>			
6-türig	6 Glastüren	300	<b>B56</b>			<b>B71</b>			
7-türig	5 Glastüren	350	<b>B57</b>			<b>B72</b>			
7-türig	7 Glastüren	350	<b>B58</b>			<b>B73</b>			
8-türig	6 Glastüren	400	<b>B59</b>			<b>B74</b>			
8-türig	8 Glastüren	400	<b>B60</b>			<b>B75</b>			



## Drehtürenschränke

ohne Kranzleiste

Tiefe: 58 cm

### Innenausstattung:

2 Einlegeböden, 1 Kleiderstange je Fach

Alle Drehtüren inkl. gedämpfter Scharniere

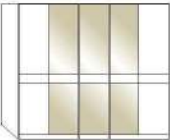
Beschreibung	Breite in cm	Höhe 216 cm			Höhe 236 cm					
		Art.-Nr.	PG 1 EURO	PG 2 EURO	PG 3 EURO	Art.-Nr.	PG 1 EURO	PG 2 EURO	PG 3 EURO	
 <p><b>mit Griffen in chrom</b></p>  <p><b>Front in Glas Champagner mit Querriegel in massiv, wahlweise Außentüren in Holz</b></p> <p>Art.-Nr. B83 / B98</p>										
	1-türig	1 Glastür, links ang.	50	<b>B76</b>				<b>B91</b>		
	1-türig	1 Glastür, rechts ang.	50	<b>B77</b>				<b>B92</b>		
	2-türig	2 Glastüren	100	<b>B78</b>				<b>B93</b>		
	3-türig	1 Glastür	150	<b>B79</b>				<b>B94</b>		
	3-türig	3 Glastüren	150	<b>B80</b>				<b>B95</b>		
	4-türig	2 Glastüren	200	<b>B81</b>				<b>B96</b>		
	4-türig	4 Glastüren	200	<b>B82</b>				<b>B97</b>		
	5-türig	3 Glastüren	250	<b>B83</b>				<b>B98</b>		
	5-türig	5 Glastüren	250	<b>B84</b>				<b>B99</b>		
	6-türig	4 Glastüren	300	<b>B85</b>				<b>P01</b>		
	6-türig	6 Glastüren	300	<b>B86</b>				<b>P02</b>		
	7-türig	5 Glastüren	350	<b>B87</b>				<b>P03</b>		
	7-türig	7 Glastüren	350	<b>B88</b>				<b>P04</b>		
	8-türig	6 Glastüren	400	<b>B89</b>				<b>P05</b>		
	8-türig	8 Glastüren	400	<b>B90</b>				<b>P06</b>		

## Drehtürenschränke

ohne Kranzleiste

Tiefe: 58 cm

### Innenausstattung:

2 Einlegeböden, 1 Kleiderstange je Fach

Alle Drehtüren inkl. gedämpfter Scharniere

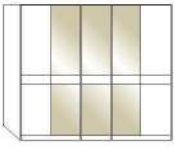
Beschreibung	Breite in cm	Höhe 216 cm			Höhe 236 cm				
		Art.-Nr.	PG 1 EURO	PG 2 EURO	PG 3 EURO	Art.-Nr.	PG 1 EURO	PG 2 EURO	PG 3 EURO
 mit Griffen in Schiefer   Front in Glas Champagner mit Querriegel in massiv, wahlweise Außentüren in Holz  Art.-Nr. P14 / P29									
1-türig	1 Glastür, links ang.	50	<b>P07</b>				<b>P22</b>		
1-türig	1 Glastür, rechts ang.	50	<b>P08</b>				<b>P23</b>		
2-türig	2 Glastüren	100	<b>P09</b>				<b>P24</b>		
3-türig	1 Glastür	150	<b>P10</b>				<b>P25</b>		
3-türig	3 Glastüren	150	<b>P11</b>				<b>P26</b>		
4-türig	2 Glastüren	200	<b>P12</b>				<b>P27</b>		
4-türig	4 Glastüren	200	<b>P13</b>				<b>P28</b>		
5-türig	3 Glastüren	250	<b>P14</b>				<b>P29</b>		
5-türig	5 Glastüren	250	<b>P15</b>				<b>P30</b>		
6-türig	4 Glastüren	300	<b>P16</b>				<b>P31</b>		
6-türig	6 Glastüren	300	<b>P17</b>				<b>P32</b>		
7-türig	5 Glastüren	350	<b>P18</b>				<b>P33</b>		
7-türig	7 Glastüren	350	<b>P19</b>				<b>P34</b>		
8-türig	6 Glastüren	400	<b>P20</b>				<b>P35</b>		
8-türig	8 Glastüren	400	<b>P21</b>				<b>P36</b>		



## Drehtürenschränke

ohne Kranzleiste

Tiefe: 58 cm

### Innenausstattung:

2 Einlegeböden, 1 Kleiderstange je Fach

Alle Drehtüren inkl. gedämpfter Scharniere

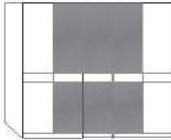
Beschreibung	Breite in cm	Höhe 216 cm			Höhe 236 cm					
		Art.-Nr.	PG 1 EURO	PG 2 EURO	PG 3 EURO	Art.-Nr.	PG 1 EURO	PG 2 EURO	PG 3 EURO	
 <p><b>mit Griffen in chrom</b></p>  <p><b>Front in Glas Mocca mit Querriegel in massiv, wahlweise Außentüren in Holz</b></p> <p>Art.-Nr. P44 / P59</p>										
	1-türig	1 Glastür, links ang.	50	<b>P37</b>				<b>P52</b>		
	1-türig	1 Glastür, rechts ang.	50	<b>P38</b>				<b>P53</b>		
	2-türig	2 Glastüren	100	<b>P39</b>				<b>P54</b>		
	3-türig	1 Glastür	150	<b>P40</b>				<b>P55</b>		
	3-türig	3 Glastüren	150	<b>P41</b>				<b>P56</b>		
	4-türig	2 Glastüren	200	<b>P42</b>				<b>P57</b>		
	4-türig	4 Glastüren	200	<b>P43</b>				<b>P58</b>		
	5-türig	3 Glastüren	250	<b>P44</b>				<b>P59</b>		
	5-türig	5 Glastüren	250	<b>P45</b>				<b>P60</b>		
	6-türig	4 Glastüren	300	<b>P46</b>				<b>P61</b>		
	6-türig	6 Glastüren	300	<b>P47</b>				<b>P62</b>		
	7-türig	5 Glastüren	350	<b>P48</b>				<b>P63</b>		
	7-türig	7 Glastüren	350	<b>P49</b>				<b>P64</b>		
	8-türig	6 Glastüren	400	<b>P50</b>				<b>P65</b>		
	8-türig	8 Glastüren	400	<b>P51</b>				<b>P66</b>		

## Drehtürenschränke

ohne Kranzleiste

Tiefe: 58 cm

### Innenausstattung:

2 Einlegeböden, 1 Kleiderstange je Fach

Alle Drehtüren inkl. gedämpfter Scharniere

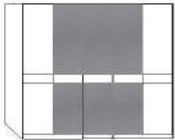
Beschreibung	Breite in cm	Höhe 216 cm			Höhe 236 cm				
		Art.-Nr.	PG 1 EURO	PG 2 EURO	PG 3 EURO	Art.-Nr.	PG 1 EURO	PG 2 EURO	PG 3 EURO
 mit Griffen in Schiefer   Front in Glas Mocca mit Querriegel in massiv, wahlweise Außentüren in Holz  Art.-Nr. P74 / P89									
1-türig	1 Glastür, links ang.	50	<b>P67</b>				<b>P82</b>		
1-türig	1 Glastür, rechts ang.	50	<b>P68</b>				<b>P83</b>		
2-türig	2 Glastüren	100	<b>P69</b>				<b>P84</b>		
3-türig	1 Glastür	150	<b>P70</b>				<b>P85</b>		
3-türig	3 Glastüren	150	<b>P71</b>				<b>P86</b>		
4-türig	2 Glastüren	200	<b>P72</b>				<b>P87</b>		
4-türig	4 Glastüren	200	<b>P73</b>				<b>P88</b>		
5-türig	3 Glastüren	250	<b>P74</b>				<b>P89</b>		
5-türig	5 Glastüren	250	<b>P75</b>				<b>P90</b>		
6-türig	4 Glastüren	300	<b>P76</b>				<b>P91</b>		
6-türig	6 Glastüren	300	<b>P77</b>				<b>P92</b>		
7-türig	5 Glastüren	350	<b>P78</b>				<b>P93</b>		
7-türig	7 Glastüren	350	<b>P79</b>				<b>P94</b>		
8-türig	6 Glastüren	400	<b>P80</b>				<b>P95</b>		
8-türig	8 Glastüren	400	<b>P81</b>				<b>P96</b>		









## Ausgebauter Eckschrank ohne Kranzleiste

### Innenausstattung:

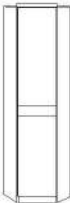

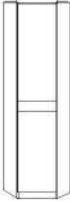

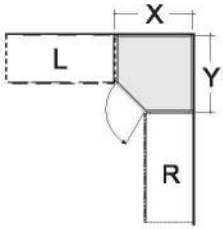
1 Einlegeboden, 1 Kleiderstange

Alle Drehtüren inkl. gedämpfter Scharniere

Beschreibung	Breite in cm	Höhe 216 cm			Höhe 236 cm				
		Art.-Nr.	PG 1 EURO	PG 2 EURO	PG 3 EURO	Art.-Nr.	PG 1 EURO	PG 2 EURO	PG 3 EURO
 <b>mit Griffen in Schiefer</b>									
 <b>Mit Querriegel in massiv Tür LINKS angeschlagen:</b>									
- Front in Massivholz	93/93	<b>C57</b>				<b>C67</b>			
- Front Spiegelglas in Parsol-Bronze	93/93	<b>C58</b>				<b>C68</b>			
- Front Glas weiß	93/93	<b>C59</b>				<b>C69</b>			
- Front Glas Champagner	93/93	<b>C60</b>				<b>C70</b>			
- Front Glas mocca	93/93	<b>C61</b>				<b>C71</b>			
 <b>mit Griffen in Schiefer</b>									
 <b>Mit Querriegel in massiv Tür RECHTS angeschlagen:</b>									
- Front in Massivholz	93/93	<b>C62</b>				<b>C72</b>			
- Front Spiegelglas in Parsol-Bronze	93/93	<b>C63</b>				<b>C73</b>			
- Front Glas weiß	93/93	<b>C64</b>				<b>C74</b>			
- Front Glas Champagner	93/93	<b>C65</b>				<b>C75</b>			
- Front Glas mocca	93/93	<b>C66</b>				<b>C76</b>			
 									

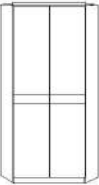
## Begehbarer Eckschrank ohne Kranzleiste

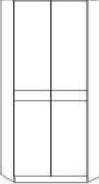
Alle Drehtüren inkl. gedämpfter Scharniere

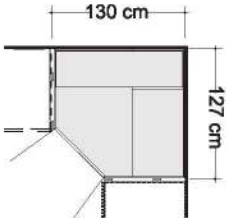
Beschreibung	Breite in cm	Höhe 216 cm			Höhe 236 cm				
		Art.-Nr.	PG 1 EURO	PG 2 EURO	PG 3 EURO	Art.-Nr.	PG 1 EURO	PG 2 EURO	PG 3 EURO
 <b>mit Griffen in chrom</b>									
 <b>Mit Querriegel in massiv</b>									
- Front in Massivholz	130/127	<b>C77</b>				<b>C87</b>			
- Front Spiegelglas in Parsol-Bronze	130/127	<b>C78</b>				<b>C88</b>			
- Front Glas weiß	130/127	<b>C79</b>				<b>C89</b>			
- Front Glas Champagner	130/127	<b>C80</b>				<b>C90</b>			
- Front Glas mocca	130/127	<b>C81</b>				<b>C91</b>			
 <b>mit Griffen in Schiefer</b>									
 <b>Mit Querriegel in massiv</b>									
- Front in Massivholz	130/127	<b>C82</b>				<b>C92</b>			
- Front Spiegelglas in Parsol-Bronze	130/127	<b>C83</b>				<b>C93</b>			
- Front Glas weiß	130/127	<b>C84</b>				<b>C94</b>			
- Front Glas Champagner	130/127	<b>C85</b>				<b>C95</b>			
- Front Glas mocca	130/127	<b>C86</b>				<b>C96</b>			
<b>Innenausstattung:</b> B 72,2 cm: 2 E-Böden, 1 Kleiderstange, B 125 cm: 5 E-Böden, Beleuchtung mit Bewegungsmelder									
 									





## Abschlusschränke ohne Kranzleiste

### Innenausstattung:

4 Einlegeböden

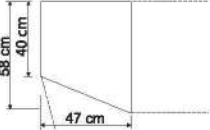
Alle Drehtüren inkl. gedämpfter Scharniere



Beschreibung	Breite in cm	Höhe 216 cm			Höhe 236 cm				
		Art.-Nr.	PG 1 EURO	PG 2 EURO	PG 3 EURO	Art.-Nr.	PG 1 EURO	PG 2 EURO	PG 3 EURO
 <p><b>mit Griffen in chrom</b></p> <p><b>Links anstellbar,</b> mit Querriegel in massiv</p>  <ul style="list-style-type: none"> <li>- Front in Massivholz</li> <li>- Front Spiegelglas in Parsol-Bronze</li> <li>- Front Glas weiß</li> <li>- Front Glas Champagner</li> <li>- Front Glas mocca</li> </ul> <p><b>Nicht einzeln stellbar!</b></p> <p><b>Nicht in Verbindung mit Schwebetüren- schränken verwendbar!</b></p>	47	<b>C97</b>				<b>F08</b>			
	47	<b>C98</b>				<b>F09</b>			
	47	<b>C99</b>				<b>F10</b>			
	47	<b>F01</b>				<b>F11</b>			
	47	<b>F02</b>				<b>F12</b>			
 <p><b>mit Griffen in chrom</b></p> <p><b>Rechts anstellbar,</b> mit Querriegel in massiv</p>  <ul style="list-style-type: none"> <li>- Front in Massivholz</li> <li>- Front Spiegelglas in Parsol-Bronze</li> <li>- Front Glas weiß</li> <li>- Front Glas Champagner</li> <li>- Front Glas mocca</li> </ul> <p><b>Nicht einzeln stellbar!</b></p> <p><b>Nicht in Verbindung mit Schwebetüren- schränken verwendbar!</b></p>	47	<b>F03</b>				<b>F13</b>			
	47	<b>F04</b>				<b>F14</b>			
	47	<b>F05</b>				<b>F15</b>			
	47	<b>F06</b>				<b>F16</b>			
	47	<b>F07</b>				<b>F17</b>			

## Abschlusschränke ohne Kranzleiste

### Innenausstattung:

4 Einlegeböden

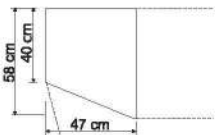
Alle Drehtüren inkl. gedämpfter Scharniere

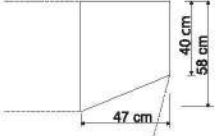
Beschreibung	Breite in cm	Höhe 216 cm			Höhe 236 cm				
		Art.-Nr.	PG 1 EURO	PG 2 EURO	PG 3 EURO	Art.-Nr.	PG 1 EURO	PG 2 EURO	PG 3 EURO
 <p><b>mit Griffen in Schiefer</b></p> <p><b>Links anstellbar,</b> mit Querriegel in massiv</p>  <ul style="list-style-type: none"> <li>- Front in Massivholz</li> <li>- Front Spiegelglas in Parsol-Bronze</li> <li>- Front Glas weiß</li> <li>- Front Glas Champagner</li> <li>- Front Glas mocca</li> </ul> <p><b>Nicht einzeln stellbar!</b></p> <p><b>Nicht in Verbindung mit Schwebetüren-</b> <b>schränken verwendbar!</b></p>	47	<b>F18</b>				<b>F28</b>			
	47	<b>F19</b>				<b>F29</b>			
	47	<b>F20</b>				<b>F30</b>			
	47	<b>F21</b>				<b>F31</b>			
	47	<b>F22</b>				<b>F32</b>			
 <p><b>mit Griffen in Schiefer</b></p> <p><b>Rechts anstellbar,</b> mit Querriegel in massiv</p>  <ul style="list-style-type: none"> <li>- Front in Massivholz</li> <li>- Front Spiegelglas in Parsol-Bronze</li> <li>- Front Glas weiß</li> <li>- Front Glas Champagner</li> <li>- Front Glas mocca</li> </ul> <p><b>Nicht einzeln stellbar!</b></p> <p><b>Nicht in Verbindung mit Schwebetüren-</b> <b>schränken verwendbar!</b></p>	47	<b>F23</b>				<b>F33</b>			
	47	<b>F24</b>				<b>F34</b>			
	47	<b>F25</b>				<b>F35</b>			
	47	<b>F26</b>				<b>F36</b>			
	47	<b>F27</b>				<b>F37</b>			



## Eckschrank-Maßübersicht

Bedingt durch unterschiedliche Tiefen-Abmessungen ergibt sich folgender Platzbedarf:

Schrank Schenkel L	Schrank Schenkel R	Platzbedarf für begehbare Ecke
Drehtürenschränk, Regalelement	SWT-Schrank, 2-4-türig	$X = 98,0 \text{ cm}$ $Y = 94,2 \text{ cm}$
SWT-Schrank, 2-türig	Drehtürenschränk, Regalelement	$X = 94,2 \text{ cm}$ $Y = 101,0 \text{ cm}$
SWT-Schrank, 3-4-türig	Drehtürenschränk, Regalelement	$X = 94,2 \text{ cm}$ $Y = 98,0 \text{ cm}$
SWT-Schrank, 2-türig	SWT-Schrank, 2-4-türig	$X = 99,2 \text{ cm}$ $Y = 102,2 \text{ cm}$
SWT-Schrank, 3-4-türig	SWT-Schrank, 2-4-türig	$X = 99,2 \text{ cm}$ $Y = 99,2 \text{ cm}$



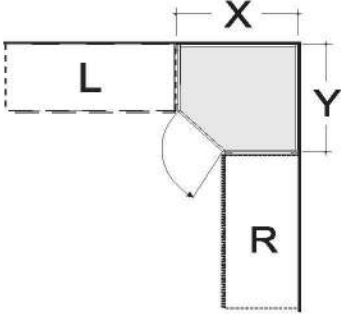

**Eckschrank vollausgebaut**

Schrank Schenkel L	Schrank Schenkel R	Platzbedarf für begehbare Ecke
Drehtürenschränk, Regalelement	SWT-Schrank, 2-4-türig	$X = 134,4 \text{ cm}$ $Y = 126,9 \text{ cm}$
SWT-Schrank, 2-türig	Drehtürenschränk, Regalelement	$X = 130,6 \text{ cm}$ $Y = 134,2 \text{ cm}$
SWT-Schrank, 3-4-türig	Drehtürenschränk, Regalelement	$X = 130,6 \text{ cm}$ $Y = 131,2 \text{ cm}$
SWT-Schrank, 2-türig	SWT-Schrank, 2-4-türig	$X = 135,6 \text{ cm}$ $Y = 135,4 \text{ cm}$
SWT-Schrank, 3-4-türig	SWT-Schrank, 2-4-türig	$X = 135,6 \text{ cm}$ $Y = 132,4 \text{ cm}$



**Begehbare Eckschrank mit Drehtüren**

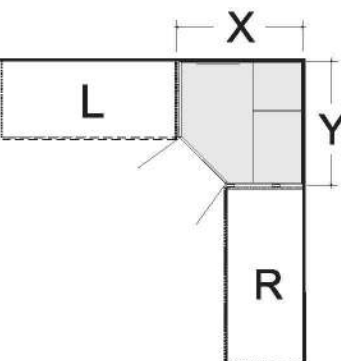

  





## Regalelement

ohne Kranzleiste

Tiefe: 36 cm

Beschreibung	Breite in cm	Höhe 216 cm			Höhe 236 cm				
		Art.-Nr.	PG 1 EURO	PG 2 EURO	PG 3 EURO	Art.-Nr.	PG 1 EURO	PG 2 EURO	PG 3 EURO
 <p><b>Regalelement offen mit 5 Einlegeböden</b></p> <p><b>Nicht in Verbindung mit Schwebetürenschränken verwendbar!</b></p>	40	<b>F38</b>				<b>F39</b>			

## Passepartout-Rahmen für Drehtürenschränke mit oder ohne Beleuchtung

Beschreibung	Maße in cm		Höhe 220 cm		Höhe 240 cm		
	B	T	Art.-Nr.	EURO	Art.-Nr.	EURO	
 <p><b>Ohne Beleuchtung,</b> Breite je Seitenstollen: 3,2 cm</p> <p><b>Draufsicht Schrank inkl. PPT-Rahmen</b></p> <p>Maße in cm</p>	- für Schrankbreite 50 cm	56,4	12,5	<b>F40</b>		<b>F56</b>	
	- für Schrankbreite 100 cm	106,4	12,5	<b>F41</b>		<b>F57</b>	
	- für Schrankbreite 150 cm	156,4	12,5	<b>F42</b>		<b>F58</b>	
	- für Schrankbreite 200 cm	206,4	12,5	<b>F43</b>		<b>F59</b>	
	- für Schrankbreite 250 cm	256,4	12,5	<b>F44</b>		<b>F60</b>	
	- für Schrankbreite 300 cm	306,4	12,5	<b>F45</b>		<b>F61</b>	
	- für Schrankbreite 350 cm	356,4	12,5	<b>F46</b>		<b>F62</b>	
	- für Schrankbreite 400 cm	406,4	12,5	<b>F47</b>		<b>F63</b>	
	 <p><b>Aufpreis für umlaufende LED-Beleuchtung (optional):</b></p>	- für Schrankbreite 50 cm	56,4	12,5	<b>F48</b>		<b>F64</b>
		- für Schrankbreite 100 cm	106,4	12,5	<b>F49</b>		<b>F65</b>
- für Schrankbreite 150 cm		156,4	12,5	<b>F50</b>		<b>F66</b>	
- für Schrankbreite 200 cm		206,4	12,5	<b>F51</b>		<b>F67</b>	
- für Schrankbreite 250 cm		256,4	12,5	<b>F52</b>		<b>F68</b>	
- für Schrankbreite 300 cm		306,4	12,5	<b>F53</b>		<b>F69</b>	
- für Schrankbreite 350 cm		356,4	12,5	<b>F54</b>		<b>F70</b>	
- für Schrankbreite 400 cm		406,4	12,5	<b>F55</b>		<b>F71</b>	





Dieses Produkt enthält Lichtquellen der Energieeffizienzklasse



**Bitte beachten:**

Bei Verwendung eines Passepartout-Rahmens verbreitert sich der Schrank auf die ausgewiesenen Maße.

## Passepartout-Rahmen für Drehtürenschränke mit Beleuchtung

Beschreibung	Maße in cm		Höhe 220 cm		Höhe 240 cm	
	B	T	Art.-Nr.	EURO	Art.-Nr.	EURO
 <p><b>Mit LED-Beleuchtung,</b> Breite je Seitenstollen: 3,2 cm</p> <p><b>Draufsicht Schrank inkl. PPT-Rahmen</b></p> <p>Maße in cm</p> <p>Dieses Produkt enthält Lichtquellen der Energieeffizienzklasse F</p>   	1 Leuchte - für Schrankbreite 50 cm	56,4	12,5	<b>F72</b>		<b>F80</b>
	2 Leuchten - für Schrankbreite 100 cm	106,4	12,5	<b>F73</b>		<b>F81</b>
	3 Leuchten - für Schrankbreite 150 cm	156,4	12,5	<b>F74</b>		<b>F82</b>
	4 Leuchten - für Schrankbreite 200 cm	206,4	12,5	<b>F75</b>		<b>F83</b>
	5 Leuchten - für Schrankbreite 250 cm	256,4	12,5	<b>F76</b>		<b>F84</b>
	6 Leuchten - für Schrankbreite 300 cm	306,4	12,5	<b>F77</b>		<b>F85</b>
	7 Leuchten - für Schrankbreite 350 cm	356,4	12,5	<b>F78</b>		<b>F86</b>
	8 Leuchten - für Schrankbreite 400 cm	406,4	12,5	<b>F79</b>		<b>F87</b>

**Bitte beachten:**

Bei Verwendung eines Passepartout-Rahmens verbreitert sich der Schrank auf die ausgewiesenen Maße.

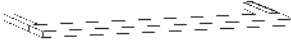

## Kranzleisten ohne Beleuchtung

Beschreibung	Maße in cm			Art.-Nr.	EURO
	B	H	T		
 <p><b>Kranzleiste,</b> ohne Beleuchtung</p>					
- für Schrankbreite 50 cm	50	3,2	12,5	<b>F88</b>	
- für Schrankbreite 100 cm	100	3,2	12,5	<b>F89</b>	
- für Schrankbreite 150 cm	150	3,2	12,5	<b>F90</b>	
- für Schrankbreite 200 cm	200	3,2	12,5	<b>F91</b>	
- für Schrankbreite 250 cm	250	3,2	12,5	<b>F92</b>	
- für Schrankbreite 300 cm	300	3,2	12,5	<b>F93</b>	
- für Schrankbreite 350 cm	350	3,2	12,5	<b>F94</b>	
- für Schrankbreite 400 cm	400	3,2	12,5	<b>F95</b>	
<b>Für Eckschränke:</b>					
- für ausgebauten Eckschrank	65	3,2	12,5	<b>F96</b>	
- für begehbaren Eckschrank	114	3,2	12,5	<b>F97</b>	
<b>Für Abschlusschränke:</b>					
- für Abschlusschrank links	55,5	3,2	12,5	<b>F98</b>	
- für Abschlusschrank rechts	55,5	3,2	12,5	<b>F99</b>	
- für Regalelement	40	3,2	12,5	<b>G01</b>	

Draufsicht Schrank  
inkl. Kranzleiste

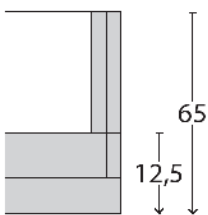

Maße in cm

## Kranzleisten mit Beleuchtung

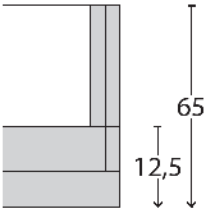
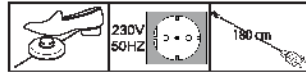
Beschreibung	Maße in cm			Art.-Nr.	EURO
	B	H	T		
 <p><b>Kranzleiste, mit Beleuchtung</b></p>					
1 Leuchte - für Schrankbreite 50 cm	50	3,2	12,5	<b>G02</b>	
2 Leuchten - für Schrankbreite 100 cm	100	3,2	12,5	<b>G03</b>	
3 Leuchten - für Schrankbreite 150 cm	150	3,2	12,5	<b>G04</b>	
4 Leuchten - für Schrankbreite 200 cm	200	3,2	12,5	<b>G05</b>	
5 Leuchten - für Schrankbreite 250 cm	250	3,2	12,5	<b>G06</b>	
6 Leuchten - für Schrankbreite 300 cm	300	3,2	12,5	<b>G07</b>	
7 Leuchten - für Schrankbreite 350 cm	350	3,2	12,5	<b>G08</b>	
8 Leuchten - für Schrankbreite 400 cm	400	3,2	12,5	<b>G09</b>	
<p><b>Draufsicht Schrank inkl. Kranzleiste</b></p>  <p>Maße in cm</p>					
<p>Dieses Produkt enthält Lichtquellen der Energieeffizienzklasse F</p> 					
<p><b>Für Eckschränke:</b></p>					
1 Leuchte - für ausgebauten Eckschrank	65	3,2	12,5	<b>G10</b>	
2 Leuchten - für begehbaren Eckschrank	114	3,2	12,5	<b>G11</b>	
<p><b>Für Abschlusschränke:</b></p>					
- für Abschlusschrank links 1 Leuchte	55,5	3,2	12,5	<b>G12</b>	
- für Abschlusschrank rechts 1 Leuchte	55,5	3,2	12,5	<b>G13</b>	
- für Regalelement 1 Leuchte	40	3,2	12,5	<b>G14</b>	

## Schwebetürenschränke ohne Kranzleiste, Griffleisten im Korpus-Farbton

**Innenausstattung:**  
2 Einlegeböden, 1 Kleiderstange  
**Tiefe: 67 cm**

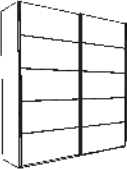
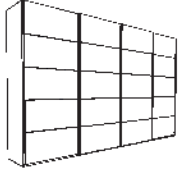
Beschreibung	Breite in cm	Höhe 217 cm			Höhe 236 cm			
		Art.-Nr.	PG 1 EURO	PG 2 EURO	PG 3 EURO	Art.-Nr.	PG 1 EURO	PG 2 EURO
 <p><b>Front aus Massivholz mit 5 Feldern</b></p> <p>2-türig</p> <p>2-türig</p> <p>3-türig</p> <p>3-türig</p> <p>3-türig</p>	150	<b>772</b>			<b>775</b>			
	200	<b>475</b>			<b>476</b>			
	225	<b>773</b>			<b>776</b>			
	250	<b>431</b>			<b>453</b>			
	300	<b>432</b>			<b>454</b>			
	 <p><b>- mit Synchronöffnung</b></p> <p>4-türig</p> <p>4-türig</p> <p>4-türig</p>	300	<b>774</b>			<b>777</b>		
330		<b>441</b>			<b>455</b>			
400		<b>442</b>			<b>456</b>			



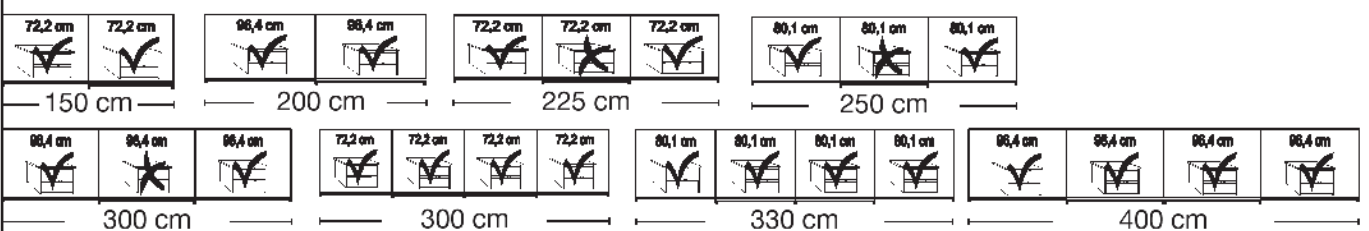

### Sockel-Aufteilung



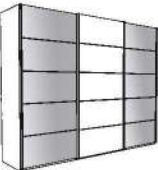

## Schwebetürenschränke ohne Kranzleiste, Griffleisten im Korpus-Farbton

**Innenausstattung:**  
2 Einlegeböden, 1 Kleiderstange  
**Tiefe: 67 cm**

Beschreibung	Breite in cm	Höhe 217 cm			Höhe 236 cm				
		Art.-Nr.	PG 1 EURO	PG 2 EURO	PG 3 EURO	Art.-Nr.	PG 1 EURO	PG 2 EURO	PG 3 EURO
<b>Massivholztüren außen, mittlere Tür /en Spiegel in Parsol-Bronze mit 5 Feldern</b>									
	2-türig 1 Spiegeltür links	150	778				786		
	2-türig 1 Spiegeltür rechts	150	779				787		
	2-türig 1 Spiegeltür links	200	477				479		
	2-türig 1 Spiegeltür rechts	200	478				480		
	3-türig	225	781				788		
	3-türig	250	438				471		
	3-türig	300	440				472		
	- mit Synchronöffnung								
	4-türig	300	783				790		
	4-türig	330	469				473		
	4-türig	400	470				474		
<b>Außentüren in Parsol-Bronze-Spiegel, mittlere Tür/en in massiv mit 5 Feldern</b>									
	3-türig	225	784				791		
	3-türig	250	517				521		
	3-türig	300	518				522		
- mit Synchronöffnung									
	4-türig	300	785				792		
	4-türig	330	519				523		
	4-türig	400	520				524		

### Sockel-Aufteilung

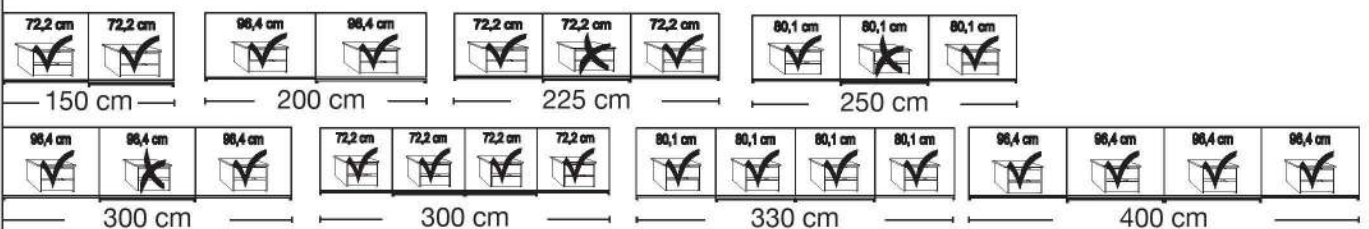

## Schwebetürenschränke ohne Kranzleiste, Griffleisten im Korpus-Farbton

Innenausstattung:  
2 Einlegeböden, 1 Kleiderstange  
Tiefe: 67 cm

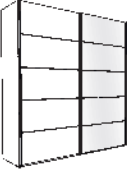
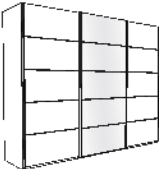
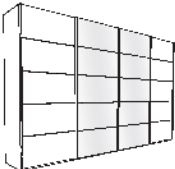
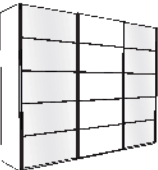
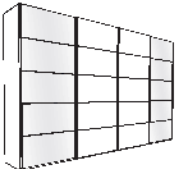

Beschreibung	Breite in cm	Höhe 217 cm			Höhe 236 cm				
		Art.-Nr.	PG 1 EURO	PG 2 EURO	PG 3 EURO	Art.-Nr.	PG 1 EURO	PG 2 EURO	PG 3 EURO
<b>Massivholztüren außen, mittlere Tür/en Glas weiß mit 5 Feldern</b>									
	2-türig 1 Glastür links	150	793				800		
	2-türig 1 Glastür rechts	150	794				801		
	2-türig 1 Glastür links	200	505				507		
	2-türig 1 Glastür rechts	200	506				508		
	3-türig	225	795				802		
	3-türig	250	409				457		
	3-türig	300	427				458		
<b>- mit Synchronöffnung</b>									
	4-türig	300	797				804		
	4-türig	330	443				459		
	4-türig	400	444				460		
<b>Außentüren in Glas weiß, mittlere Tür/en in massiv mit 5 Feldern</b>									
	3-türig	225	798				805		
	3-türig	250	525				533		
	3-türig	300	526				534		
<b>- mit Synchronöffnung</b>									
	4-türig	300	799				806		
	4-türig	330	527				535		
	4-türig	400	528				536		

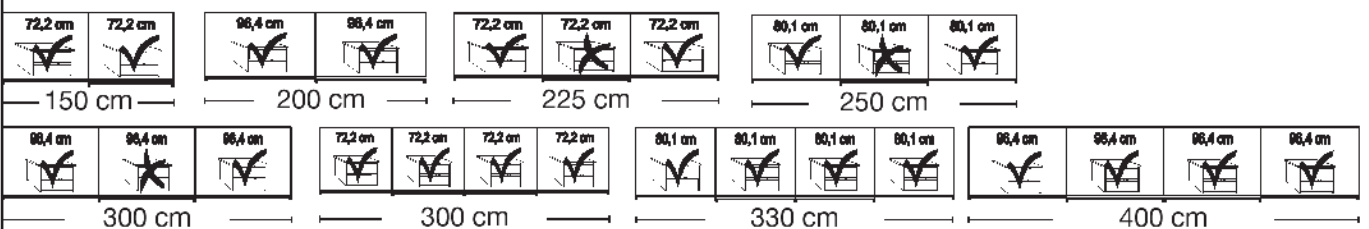
### Sockel-Aufteilung

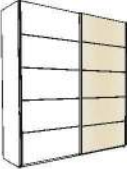
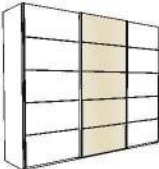

## Schwebetürenschränke ohne Kranzleiste, Griffleisten im Korpus-Farbton

**Innenausstattung:**  
2 Einlegeböden, 1 Kleiderstange  
**Tiefe: 67 cm**

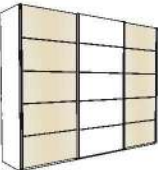
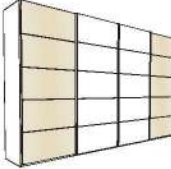



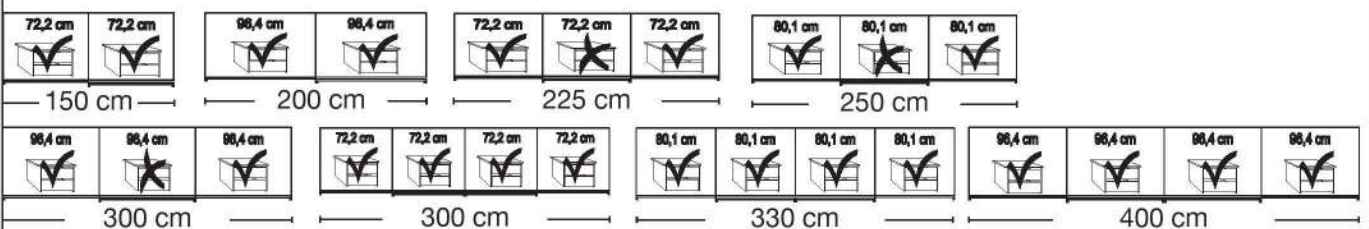





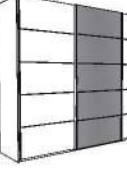

Beschreibung	Breite in cm	Höhe 217 cm			Höhe 236 cm				
		Art.-Nr.	PG 1 EURO	PG 2 EURO	PG 3 EURO	Art.-Nr.	PG 1 EURO	PG 2 EURO	PG 3 EURO
<b>Massivholztüren außen, mittlere Tür/en Glas Champagner mit 5 Feldern</b>									
	2-türig 1 Glastür links	150	807				813		
	2-türig 1 Glastür rechts	150	808				814		
	2-türig 1 Glastür links	200	509				511		
	2-türig 1 Glastür rechts	200	510				512		
	3-türig	225	809				826		
	3-türig	250	445				461		
	3-türig	300	446				462		
<b>- mit Synchronöffnung</b>									
	4-türig	300	810				828		
	4-türig	330	447				463		
	4-türig	400	448				464		
<b>Außentüren in Glas Champagner, mittlere Tür/en in massiv mit 5 Feldern</b>									
	3-türig	225	811				829		
	3-türig	250	529				537		
	3-türig	300	530				538		
<b>- mit Synchronöffnung</b>									
	4-türig	300	812				830		
	4-türig	330	531				539		
	4-türig	400	532				540		

### Sockel-Aufteilung

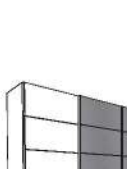
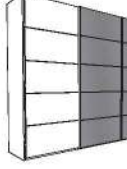

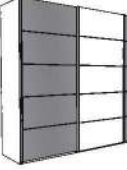
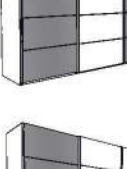
## Schwebetürenschränke ohne Kranzleiste, Griffleisten im Korpus-Farbton

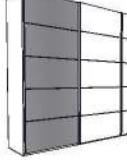
**Innenausstattung:**  
2 Einlegeböden, 1 Kleiderstange  
**Tiefe: 67 cm**





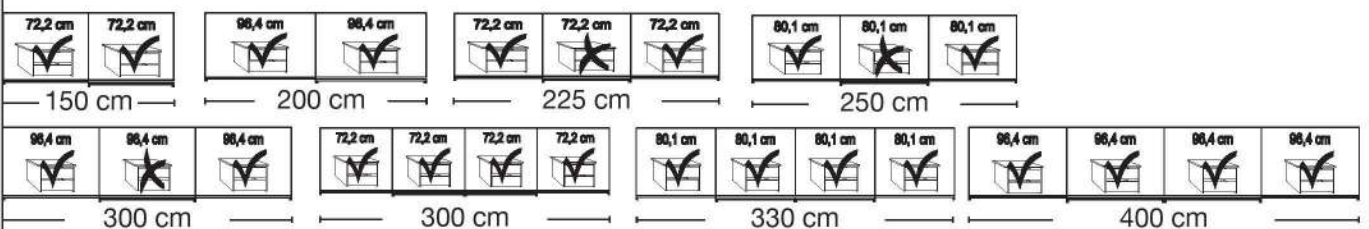

Beschreibung	Breite in cm	Höhe 217 cm			Höhe 236 cm				
		Art.-Nr.	PG 1 EURO	PG 2 EURO	PG 3 EURO	Art.-Nr.	PG 1 EURO	PG 2 EURO	PG 3 EURO
<b>Massivholztüren außen, mittlere Tür/en Glas Mocca mit 5 Feldern</b>									
 2-türig 1 Glastür links	150	831				842			
 2-türig 1 Glastür rechts	150	832				843			
 2-türig 1 Glastür links	200	760				766			
 2-türig 1 Glastür rechts	200	761				767			
 3-türig	225	833				844			
 3-türig	250	762				768			
 3-türig	300	763				769			
<b>- mit Synchronöffnung</b>									
 4-türig	300	835				846			
 4-türig	330	764				770			
 4-türig	400	765				771			
<b>Außentüren in Glas Mocca, mittlere Tür/en in massiv mit 5 Feldern</b>									
 3-türig	225	836				847			
 3-türig	250	837				848			
 3-türig	300	838				849			
<b>- mit Synchronöffnung</b>									
 4-türig	300	839				850			
 4-türig	330	840				851			
 4-türig	400	841				852			

### Sockel-Aufteilung













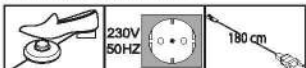

## Schrank-Zubehör

	Beschreibung	Maße in cm			Art.-Nr.	EURO
		B	H	T		
	<b>2-er Set Selbsteinzug mit Dämpfung</b> für Außentüren, Set für 2-,3-, und 4-türige Schränke  Paar	24	2	11	<b>365</b>	
	<b>Selbsteinzug mit Dämpfung</b> für Mitteltüren - für 3-türige Schränke*      Stück - für 4-türige Schränke      Stück	24	2	11	<b>363</b>	
	*  <b>Bitte Deckenhöhe beachten!</b> <b>Montage kann nur von der Schrank-Oberseite erfolgen!</b>	24	2	11	<b>364</b>	
	<b>Kollisionsdämpfer</b> - für 2-türige Schränke      1 Stück - für 3-4-türige Schränke      2 Stück	28	4	2	<b>369</b>	
	 <b>Optimale Funktion nur in Verbindung mit Außentürdämpfung</b> - für 3-4-türige Schränke      2 Stück  <b>Optimale Funktion nur in Verbindung mit Außen- und Mitteltürdämpfung!</b>	28	4	2	<b>370</b>	

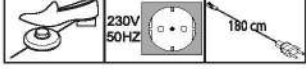
## Schrank-Zubehör

Beschreibung	Maße in cm			Art.-Nr.	EURO
	B	H	T		
 <p><b>LED-Line-Vorbauleuchte, flach in silber</b></p> <p>Dieses Produkt enthält Lichtquellen der Energieeffizienzklasse E</p>  <p>1 Stück 2 Stück 3 Stück</p> <p> <b>Nur in Verbindung mit Passepartout-Rahmen und Kranzleisten!</b></p>	60 60 60	1,5 1,5 1,5	4,5 4,5 4,5	<b>980</b> <b>981</b> <b>982</b>	
 <p><b>LED-Line-Aufbauleuchte in silber</b></p> <p>Dieses Produkt enthält Lichtquellen der Energieeffizienzklasse E</p>  <p>1 Stück 2 Stück 3 Stück</p>	60 60 60	6 6 6	19 19 19	<b>983</b> <b>984</b> <b>985</b>	
 <p><b>LED-Line-Vorbauleuchte, flach in schwarz</b></p> <p>Dieses Produkt enthält Lichtquellen der Energieeffizienzklasse E</p>  <p>1 Stück 2 Stück 3 Stück</p> <p> <b>Nur in Verbindung mit Passepartout-Rahmen und Kranzleisten!</b></p>	60 60 60	1,5 1,5 1,5	4,5 4,5 4,5	<b>880</b> <b>881</b> <b>882</b>	
 <p><b>LED-Line-Aufbauleuchte in schwarz</b></p> <p>Dieses Produkt enthält Lichtquellen der Energieeffizienzklasse E</p>  <p>1 Stück 2 Stück 3 Stück</p>	60 60 60	6 6 6	19 19 19	<b>883</b> <b>884</b> <b>885</b>	

## Passepartout-Rahmen für Schwebetürenschränke mit oder ohne Beleuchtung

Beschreibung	Maße in cm		Höhe 221 cm		Höhe 240 cm		
	B	T	Art.-Nr.	EURO	Art.-Nr.	EURO	
 <p><b>Passepartout-Rahmen,</b> Breite je Seitenstollen 5 cm <b>ohne Beleuchtung</b></p> <ul style="list-style-type: none"> <li>- für Schrankbreite 150 cm</li> <li>- für Schrankbreite 200 cm</li> <li>- für Schrankbreite 225 cm</li> <li>- für Schrankbreite 250 cm</li> </ul> <p><b>Draufsicht Schrank inkl. PPT-Rahmen</b></p> <ul style="list-style-type: none"> <li>- für Schrankbreite 300 cm</li> <li>- für Schrankbreite 300 cm</li> <li>- für Schrankbreite 330 cm</li> <li>- für Schrankbreite 400 cm</li> </ul> <p><b>Maße in cm</b></p> <p><b>⚠ - nur für 3-türige Schränke</b></p> <ul style="list-style-type: none"> <li>- für Schrankbreite 300 cm</li> <li>- für Schrankbreite 330 cm</li> <li>- für Schrankbreite 400 cm</li> </ul> <p><b>⚠ - nur für 4-türige Schränke</b></p> <p><b>⚠ Nicht in Verbindung mit Eckschränken verwendbar!</b></p>	160	23	<b>877</b>		<b>886</b>		
	210	23	<b>160</b>		<b>170</b>		
	235	23	<b>878</b>		<b>887</b>		
	260	23	<b>161</b>		<b>171</b>		
	310	23	<b>162</b>		<b>172</b>		
	310	23	<b>879</b>		<b>888</b>		
	340	23	<b>163</b>		<b>173</b>		
	410	23	<b>164</b>		<b>174</b>		
	<p><b>⚠ Nicht in Verbindung mit Eckschränken verwendbar!</b></p>						
	 <p><b>Aufpreis für umlaufende LED-Beleuchtung (optional):</b></p> <ul style="list-style-type: none"> <li>- für Schrankbreite 150 cm</li> <li>- für Schrankbreite 200 cm</li> <li>- für Schrankbreite 225 cm</li> <li>- für Schrankbreite 250 cm</li> </ul> <ul style="list-style-type: none"> <li>- für Schrankbreite 300 cm</li> <li>- für Schrankbreite 300 cm</li> <li>- für Schrankbreite 330 cm</li> <li>- für Schrankbreite 400 cm</li> </ul> <p><b>⚠ - nur für 3-türige Schränke</b></p> <ul style="list-style-type: none"> <li>- für Schrankbreite 300 cm</li> <li>- für Schrankbreite 330 cm</li> <li>- für Schrankbreite 400 cm</li> </ul>	160	23	<b>889</b>		<b>892</b>	
210		23	<b>816</b>		<b>821</b>		
235		23	<b>890</b>		<b>893</b>		
260		23	<b>817</b>		<b>822</b>		
310		23	<b>818</b>		<b>823</b>		
310		23	<b>891</b>		<b>894</b>		
340		23	<b>819</b>		<b>824</b>		
410		23	<b>820</b>		<b>825</b>		
<p><b>⚠ - nur für 3-türige Schränke</b></p> <p><b>⚠ - nur für 4-türige Schränke</b></p>							

Dieses Produkt enthält Lichtquellen der Energieeffizienzklasse F

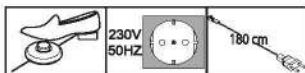

**Nicht nachträglich einbaubar!**









**Nicht in Verbindung mit Eckschränken verwendbar!**

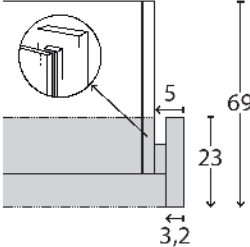

**Bitte beachten:**



Bei Verwendung eines Passepartout-Rahmens verbreitert sich der Schrank auf die ausgewiesenen Maße.

## Passepartout-Rahmen für Schwebetürenschränke mit oder ohne Beleuchtung

Beschreibung	Maße in cm		Höhe 221 cm		Höhe 240 cm	
	B	T	Art.-Nr.	EURO	Art.-Nr.	EURO
 <p><b>Passepartout-Rahmen,</b> Breite je Seitenstollen 5 cm <b>mit Beleuchtung</b></p>						
2 Leuchten für Schrankbreite 150 cm	160	23	<b>895</b>		<b>898</b>	
4 Leuchten für Schrankbreite 200 cm	210	23	<b>165</b>		<b>175</b>	
6 Leuchten für Schrankbreite 225 cm	235	23	<b>896</b>		<b>899</b>	
6 Leuchten für Schrankbreite 250 cm	260	23	<b>166</b>		<b>176</b>	
6 Leuchten für Schrankbreite 300 cm <b>⚠ - nur für 3-türige Schränke</b>	310	23	<b>167</b>		<b>177</b>	
8 Leuchten für Schrankbreite 300 cm <b>⚠ - nur für 4-türige Schränke</b>	310	23	<b>897</b>		<b>900</b>	
8 Leuchten für Schrankbreite 330 cm	340	23	<b>168</b>		<b>178</b>	
8 Leuchten für Schrankbreite 400 cm	410	23	<b>169</b>		<b>179</b>	
<b>⚠ Nicht in Verbindung mit Eckschränken verwendbar!</b>						
<p><b>Draufsicht Schrank inkl. PPT-Rahmen</b></p>  <p>Maße in cm</p> <p>Dieses Produkt enthält Lichtquellen der Energieeffizienzklasse F</p>   						
<p><b>Stollenbeleuchtung</b></p>  <p><b>⚠ Nicht nachträglich einbaubar!</b> <b>Für Passepartout-Rahmen ohne umlaufende Beleuchtung verwendbar!</b></p> <p>Dieses Produkt enthält Lichtquellen der Energieeffizienzklasse F</p>   	1,5	1	<b>100</b>		<b>101</b>	

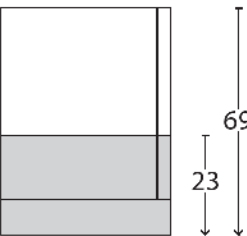

## Kranzleisten für Schwebetürenschränke mit oder ohne Beleuchtung

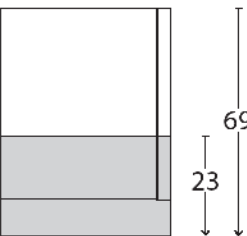

Beschreibung	Maße in cm			Art.-Nr.	EURO
	B	H	T		
 <p><b>Kranzleiste, ohne Beleuchtung</b></p> <ul style="list-style-type: none"> <li>- für Schrankbreite 150 cm</li> <li>- für Schrankbreite 200 cm</li> <li>- für Schrankbreite 225 cm</li> <li>- für Schrankbreite 250 cm</li> </ul> <p><b>Draufsicht Schrank inkl. Kranzleiste</b></p>  <p>Maße in cm</p> <ul style="list-style-type: none"> <li>- für Schrankbreite 300 cm</li> <li>⚠ - nur für 3-türige Schränke</li> <li>- für Schrankbreite 300 cm</li> <li>⚠ - nur für 4-türige Schränke</li> <li>- für Schrankbreite 330 cm</li> <li>- für Schrankbreite 400 cm</li> </ul> <p>⚠ <b>Nicht in Verbindung mit Eckschränken verwendbar!</b></p>	150	5	23	<b>901</b>	
	200	5	23	<b>860</b>	
	225	5	23	<b>902</b>	
	250	5	23	<b>861</b>	
	300	5	23	<b>862</b>	
	300	5	23	<b>903</b>	
	330	5	23	<b>863</b>	
	400	5	23	<b>864</b>	
 <p><b>Kranzleiste, mit Beleuchtung</b></p> <ul style="list-style-type: none"> <li>- für Schrankbreite 150 cm    2 Leuchten</li> <li>- für Schrankbreite 200 cm    4 Leuchten</li> <li>- für Schrankbreite 225 cm    6 Leuchten</li> <li>- für Schrankbreite 250 cm    6 Leuchten</li> </ul> <p><b>Draufsicht Schrank inkl. Kranzleiste</b></p>  <p>Maße in cm</p> <ul style="list-style-type: none"> <li>- für Schrankbreite 300 cm    6 Leuchten</li> <li>⚠ - nur für 3-türige Schränke</li> <li>- für Schrankbreite 300 cm    8 Leuchten</li> <li>⚠ - nur für 4-türige Schränke</li> <li>- für Schrankbreite 330 cm    8 Leuchten</li> <li>- für Schrankbreite 400 cm    8 Leuchten</li> </ul> <p>⚠ <b>Nicht in Verbindung mit Eckschränken verwendbar!</b></p>	150	5	23	<b>904</b>	
	200	5	23	<b>870</b>	
	225	5	23	<b>905</b>	
	250	5	23	<b>871</b>	
	300	5	23	<b>872</b>	
	300	5	23	<b>906</b>	
	330	5	23	<b>873</b>	
	400	5	23	<b>874</b>	

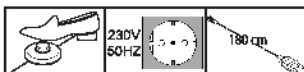
Dieses Produkt enthält Lichtquellen  
der Energieeffizienzklasse F





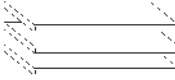

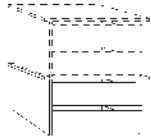
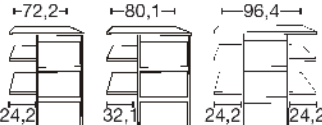
## Schrank-Zubehör

Innenausführung: Erle-Nachbildung

	Beschreibung	Maße in cm			Art.-Nr.	EURO
		B	H	T		
	<p><b>1 Einlegeboden</b></p> <ul style="list-style-type: none"> <li>- für Fachbreite 47,5 cm      1 Stück</li> <li>- für Fachbreite 72,2 cm      1 Stück</li> <li>- für Fachbreite 80,1 cm      1 Stück</li> <li>- für Fachbreite 96,4 cm      1 Stück</li> </ul>	47,5	2,2	51,5	<b>028</b>	
	<p><b>3 Einlegeböden</b></p> <ul style="list-style-type: none"> <li>- für Fachbreite 47,5 cm      3 Stück</li> <li>- für Fachbreite 72,2 cm      3 Stück</li> <li>- für Fachbreite 80,1 cm      3 Stück</li> <li>- für Fachbreite 96,4 cm      3 Stück</li> </ul>	47,5	2,2	51,5	<b>029</b>	
	<p><b>1 Kleiderstange</b></p> <ul style="list-style-type: none"> <li>- für Fachbreite 47,5 cm      1 Stück</li> <li>- für Fachbreite 72,2 cm      1 Stück</li> <li>- für Fachbreite 80,1 cm      1 Stück</li> <li>- für Fachbreite 96,4 cm      1 Stück</li> </ul>	47,5	3	2	<b>049</b>	
	<p><b>Schubkasten-Einsatz</b> mit 2 Auszügen mit Kugelauszug und GLASfront für Drehtüren- und Schwebetürenschränke</p> <ul style="list-style-type: none"> <li>- für Fachbreite 47,5 cm</li> <li>- für Fachbreite 72,2 cm</li> <li>- für Fachbreite 80,1 cm</li> <li>- für Fachbreite 96,4 cm</li> </ul>	47,5	41	52	<b>047</b>	
	<p><b>Schubkasten-Einsatz</b> mit 2 Auszügen mit Selbsteinzug und HOLZfront für Drehtüren- und Schwebetürenschränke, <b>stapelbar und auf beliebiger Höhe einbaubar</b></p> <ul style="list-style-type: none"> <li>- für Fachbreite 72,2 cm</li> <li>- für Fachbreite 80,1 cm</li> <li>- für Fachbreite 96,4 cm</li> </ul>	72,2	41	44	<b>071</b>	
 <p>Art.-Nr. 023    Art.-Nr. 024    Art.-Nr. 064</p>	<p><b>Schubkasten-Einsatz</b> mit 3 Auszügen mit Selbsteinzug und HOLZfront</p> <ul style="list-style-type: none"> <li>- für Fachbreite 72,2 cm</li> <li>- für Fachbreite 80,1 cm</li> <li>- für Fachbreite 96,4 cm</li> </ul>	72,2	89	51,5	<b>023</b>	
		80,1	89	51,5	<b>024</b>	
		96,4	89	51,5	<b>064</b>	

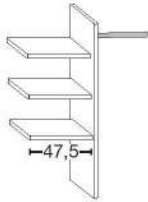

## Schrank-Zubehör

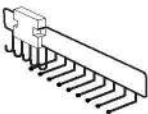
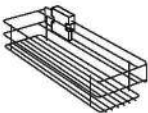
Innenausführung: Erle-Nachbildung

Beschreibung	Maße in cm			Art.-Nr.	EURO
	B	H	T		
 <p><b>Wäscheboden-Einsatz, bestehend aus:</b></p> <p>3 Einlegeböden, 1 Kleiderstange, 1 Mittelseite</p> <p>- für Fachbreite 72,2 cm - für Fachbreite 80,1 cm - für Fachbreite 96,4 cm</p>					
 <p><b>Beidseitig (links- oder rechtsseitig) verwendbar!</b></p> <p><b>Nur auf Sockelböden stellbar!</b></p>				<b>025</b>	
				<b>026</b>	
				<b>066</b>	
 <p><b>LED-Lichtblende für Einlegeböden</b></p> <p>- für Fachbreite 47,5 cm      1 Stück      47,5      3      1      <b>010</b> - für Fachbreite 72,2 cm      1 Stück      72,2      3      1      <b>002</b> - für Fachbreite 80,1 cm      1 Stück      80,1      3      1      <b>016</b> - für Fachbreite 96,4 cm      1 Stück      96,4      3      1      <b>011</b></p> <p>- für Fachbreite 47,5 cm      2 Stück      47,5      3      1      <b>012</b> - für Fachbreite 72,2 cm      2 Stück      72,2      3      1      <b>003</b> - für Fachbreite 80,1 cm      2 Stück      80,1      3      1      <b>017</b> - für Fachbreite 96,4 cm      2 Stück      96,4      3      1      <b>013</b></p> <p>- für Fachbreite 47,5 cm      3 Stück      47,5      3      1      <b>014</b> - für Fachbreite 72,2 cm      3 Stück      72,2      3      1      <b>004</b> - für Fachbreite 80,1 cm      3 Stück      80,1      3      1      <b>018</b> - für Fachbreite 96,4 cm      3 Stück      96,4      3      1      <b>015</b></p> <p><small>Dieses Produkt enthält Lichtquellen der Energieeffizienzklasse F</small></p>					
 <p><b>Ausziehbarer Hosenhalter</b></p>	45	10	50	<b>056</b>	
 <p><b>Krawatten- und Gürtel-Auszug</b></p>	7	19	45	<b>059</b>	
 <p><b>Utensilien-Auszug</b></p>	16	9	45	<b>076</b>	

## Schrank-Zubehör

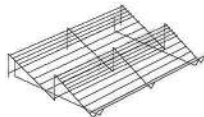

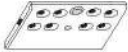
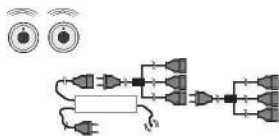

Innenausführung: Erle-Nachbildung

Beschreibung	Maße in cm			Art.-Nr.	EURO	
	B	H	T			
 <p><b>Krawatten- und Gürtelhalter</b></p>	30	27	9	<b>042</b>		
 <p><b>Schuhrost</b> für Schrankfach B 96,4 cm - für Fachbreite 96,4 cm</p>	96	15	50	<b>094</b>		
 <p><b>Kleiderlift</b> für Schrankfach-Breite 72,2 - 96,4 cm</p>	100	85	14	<b>081</b>		
 <p><b>LED-Schrankinnenbeleuchtung</b> mit Bewegungsmelder, inkl. Akku (Ladevorgang über USB)</p>						
	1 Stück	10	2	10	<b>006</b>	
	2 Stück	10	2	10	<b>007</b>	
	3 Stück	10	2	10	<b>008</b>	
	4 Stück	10	2	10	<b>009</b>	
 <p><b>Fernbedienungs-Set für Beleuchtungen mit 2 Fernbedienungen</b> Bis zu 5 Verbrauchsstellen anschließbar</p>	40	9	13	<b>005</b>		

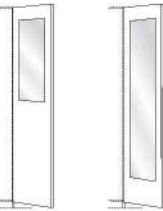

## Schrank-Zubehör

Innenausführung: Erle-Nachbildung

Beschreibung	Maße in cm			Art.-Nr.	EURO
	B	H	T		
 <p><b>Innenspiegel, klappbar</b></p> <p><b>Nicht in Verbindung mit LED-Lichtblende verwendbar!</b></p> <p> <b>Nur für Schwebetürenschränke!</b></p>	36	173	2	<b>080</b>	
 <p><b>Innenspiegel</b></p> <p><b>! ACHTUNG !</b></p> <p> Nur einsetzbar bei Drehtüren!</p> <p><b>* Nicht für Massivholztüren verwendbar!</b></p> <p>Art.-Nr. 046    Art.-Nr. 079</p>	36 36	80 173	1 1	<b>046</b> <b>079*</b>	

## Komfortbetten

Liegehöhen-Verstellung 4-fach

Bettseiten-Höhe 48 cm

Beschreibung	Liegefläche in cm	Stellfläche in cm	Art.-Nr.	PG 1 EURO	PG 2 EURO	PG 3 EURO	
 <p><b>Komfort-Betten mit Polster-Kopfteil in Kunstleder weiß und schwebendem Bettrahmen</b></p>	90 x 190	98 x 206	<b>600</b>				
	90 x 200	98 x 216	<b>601</b>				
	90 x 210	98 x 226	<b>602</b>				
	90 x 220	98 x 236	<b>603</b>				
	100 x 190	109 x 206	<b>604</b>				
	100 x 200	109 x 216	<b>605</b>				
	100 x 210	109 x 226	<b>606</b>				
	100 x 220	109 x 236	<b>607</b>				
	120 x 190	129 x 206	<b>608</b>				
	120 x 200	129 x 216	<b>609</b>				
	120 x 210	129 x 226	<b>610</b>				
	120 x 220	129 x 236	<b>611</b>				
	140 x 190	149 x 206	<b>612</b>				
	140 x 200	149 x 216	<b>613</b>				
	140 x 210	149 x 226	<b>614</b>				
	140 x 220	149 x 236	<b>615</b>				
	160 x 190	169 x 206	<b>616</b>				
	160 x 200	169 x 216	<b>617</b>				
	160 x 210	169 x 226	<b>618</b>				
	160 x 220	169 x 236	<b>619</b>				
	180 x 190	189 x 206	<b>620</b>				
	180 x 200	189 x 216	<b>621</b>				
	180 x 210	189 x 226	<b>622</b>				
	180 x 220	189 x 236	<b>623</b>				
	Höhe Kopfteil:	200 x 190	209 x 206	<b>624</b>			
	<b>96</b> cm	200 x 200	209 x 216	<b>625</b>			
	Höhe Fußteil:	200 x 210	209 x 226	<b>626</b>			
<b>48</b> cm	200 x 220	209 x 236	<b>627</b>				
Höhe Oberkante Bettseite:							
<b>48</b> cm							

## Komfortbetten

Liegehöhen-Verstellung 4-fach

Bettseiten-Höhe 48 cm

Beschreibung	Liegefläche in cm	Stellfläche in cm	Art.-Nr.	PG 1 EURO	PG 2 EURO	PG 3 EURO
 <p><b>Komfort-Betten mit Polster-Kopfteil in Kunstleder Champagner und schwebendem Bettrahmen</b></p>	90 x 190	98 x 206	<b>628</b>			
	90 x 200	98 x 216	<b>629</b>			
	90 x 210	98 x 226	<b>630</b>			
	90 x 220	98 x 236	<b>631</b>			
	100 x 190	109 x 206	<b>632</b>			
	100 x 200	109 x 216	<b>633</b>			
	100 x 210	109 x 226	<b>634</b>			
	100 x 220	109 x 236	<b>635</b>			
	120 x 190	129 x 206	<b>636</b>			
	120 x 200	129 x 216	<b>637</b>			
	120 x 210	129 x 226	<b>638</b>			
	120 x 220	129 x 236	<b>639</b>			
	140 x 190	149 x 206	<b>640</b>			
	140 x 200	149 x 216	<b>641</b>			
	140 x 210	149 x 226	<b>642</b>			
	140 x 220	149 x 236	<b>643</b>			
	160 x 190	169 x 206	<b>644</b>			
	160 x 200	169 x 216	<b>645</b>			
	160 x 210	169 x 226	<b>646</b>			
	160 x 220	169 x 236	<b>647</b>			
180 x 190	189 x 206	<b>648</b>				
180 x 200	189 x 216	<b>649</b>				
180 x 210	189 x 226	<b>651</b>				
180 x 220	189 x 236	<b>652</b>				
Höhe Kopfteil:	200 x 190	209 x 206	<b>653</b>			
<b>96</b> cm	200 x 200	209 x 216	<b>654</b>			
Höhe Fußteil:	200 x 210	209 x 226	<b>655</b>			
<b>48</b> cm	200 x 220	209 x 236	<b>656</b>			
Höhe Oberkante Bettseite:						
<b>48</b> cm						

## Komfortbetten

Liegehöhen-Verstellung 4-fach

Bettseiten-Höhe 48 cm

Beschreibung	Liegefläche in cm	Stellfläche in cm	Art.-Nr.	PG 1 EURO	PG 2 EURO	PG 3 EURO
 <p><b>Komfort-Betten mit Polster-Kopfteil in Kunstleder Mocca und schwebendem Bettrahmen</b></p>	90 x 190	98 x 206	<b>657</b>			
	90 x 200	98 x 216	<b>658</b>			
	90 x 210	98 x 226	<b>659</b>			
	90 x 220	98 x 236	<b>660</b>			
	100 x 190	109 x 206	<b>661</b>			
	100 x 200	109 x 216	<b>662</b>			
	100 x 210	109 x 226	<b>663</b>			
	100 x 220	109 x 236	<b>664</b>			
	120 x 190	129 x 206	<b>665</b>			
	120 x 200	129 x 216	<b>666</b>			
	120 x 210	129 x 226	<b>667</b>			
	120 x 220	129 x 236	<b>668</b>			
	140 x 190	149 x 206	<b>669</b>			
	140 x 200	149 x 216	<b>670</b>			
	140 x 210	149 x 226	<b>671</b>			
	140 x 220	149 x 236	<b>672</b>			
	160 x 190	169 x 206	<b>673</b>			
	160 x 200	169 x 216	<b>674</b>			
	160 x 210	169 x 226	<b>675</b>			
	160 x 220	169 x 236	<b>676</b>			
	180 x 190	189 x 206	<b>677</b>			
	180 x 200	189 x 216	<b>678</b>			
	180 x 210	189 x 226	<b>679</b>			
	180 x 220	189 x 236	<b>680</b>			
200 x 190	209 x 206	<b>681</b>				
200 x 200	209 x 216	<b>682</b>				
200 x 210	209 x 226	<b>683</b>				
200 x 220	209 x 236	<b>684</b>				

Höhe Kopfteil:

**96** cm

Höhe Fußteil:

**48** cm

Höhe Oberkante Bettseite:



**48** cm







## Komfortbetten

Liegehöhen-Verstellung 4-fach







Bettseiten-Höhe 48 cm

Beschreibung	Liegefläche in cm	Stellfläche in cm	Art.-Nr.	PG 1 EURO	PG 2 EURO	PG 3 EURO
 <p><b>Komfort-Betten mit Holzkopfteil</b></p>	90 x 190	98 x 206	<b>685</b>			
	90 x 200	98 x 216	<b>686</b>			
	90 x 210	98 x 226	<b>687</b>			
	90 x 220	98 x 236	<b>688</b>			
	100 x 190	109 x 206	<b>689</b>			
	100 x 200	109 x 216	<b>690</b>			
	100 x 210	109 x 226	<b>691</b>			
	100 x 220	109 x 236	<b>692</b>			
	120 x 190	129 x 206	<b>693</b>			
	120 x 200	129 x 216	<b>694</b>			
	120 x 210	129 x 226	<b>695</b>			
	120 x 220	129 x 236	<b>696</b>			
 <p>Höhe Kopfteil: <b>103</b> cm Höhe Fußteil: <b>48</b> cm Höhe Oberkante Bettseite: <b>48</b> cm</p>	140 x 190	149 x 206	<b>697</b>			
	140 x 200	149 x 216	<b>698</b>			
	140 x 210	149 x 226	<b>699</b>			
	140 x 220	149 x 236	<b>700</b>			
	160 x 190	169 x 206	<b>701</b>			
	160 x 200	169 x 216	<b>702</b>			
	160 x 210	169 x 226	<b>703</b>			
	160 x 220	169 x 236	<b>704</b>			
	180 x 190	189 x 206	<b>705</b>			
	180 x 200	189 x 216	<b>706</b>			
	180 x 210	189 x 226	<b>707</b>			
	180 x 220	189 x 236	<b>708</b>			
200 x 190	209 x 206	<b>709</b>				
200 x 200	209 x 216	<b>710</b>				
200 x 210	209 x 226	<b>711</b>				
200 x 220	209 x 236	<b>712</b>				

## Zusatzelemente für Betten

Beschreibung	Maße in cm			Art.-Nr.	EURO
	B	H	T		
 <p><b>LED-Flexleuchte, chrom</b></p> <p>Paar</p> <p>Dieses Produkt enthält eine Lichtquelle der Energieeffizienzklasse F</p>	50	2	4	<b>091</b>	
 <p><b>LED-Flexleuchte, Schiefer</b></p> <p>Paar</p> <p>Dieses Produkt enthält eine Lichtquelle der Energieeffizienzklasse F</p>	50	2	4	<b>092</b>	
 <p><b>LED-Ambiente-Beleuchtung zur Befestigung hinter dem Kopfteil</b></p> <p>- für Bettbreite 140 cm - für Bettbreite 160 cm - für Bettbreite 180 cm - für Bettbreite 200 cm</p> <p>Dieses Produkt enthält eine Lichtquelle der Energieeffizienzklasse F</p>	147 167 187 207	1 1 1 1	1 1 1 1	<b>095</b> <b>096</b> <b>097</b> <b>098</b>	
 <p><b>Beleuchtungsset für Fußteil</b></p> <p>Dieses Produkt enthält eine Lichtquelle der Energieeffizienzklasse E</p> <p> <b>Nur für Bettbreiten 140 cm bis 200 cm lieferbar!</b></p>	60	9	9	<b>093</b>	

## Zusatzelemente für Betten



	Beschreibung	Maße in cm			Art.-Nr.	EURO
		B	H	T		
	<b>Unterbau-Bettkasten</b> für Lattenrost mit Spring-auf-Beschlag - für Bettlänge 200 cm					
	- für Liegefläche 90 x 200 cm	87	22	190	<b>936</b>	
	- für Liegefläche 100 x 200 cm	97	22	190	<b>940</b>	
	- für Liegefläche 160 x 200 cm	157	22	190	<b>952</b>	
	- für Liegefläche 180 x 200 cm	177	22	190	<b>956</b>	
	- für Liegefläche 200 x 200 cm	197	22	190	<b>960</b>	
   <b>Nicht für Bettbreiten 120 cm und 140 cm lieferbar!</b>    	<b>Lattenroste mit Springauf-Beschlag - für Bettlänge 200 cm</b>					
	- für Liegefläche 90 x 200 cm	90	9	200	<b>963</b>	
	- für Liegefläche 100 x 200 cm	100	9	200	<b>964</b>	
	- für Liegefläche 160 x 200 cm	2 x 80	9	200	<b>966</b>	
	- für Liegefläche 180 x 200 cm	2 x 90	9	200	<b>967</b>	
	- für Liegefläche 200 x 200 cm	2 x 100	9	200	<b>968</b>	



Hier finden Sie weitere Informationen

## Nachtschränke, 1 Auszug schwebend, Höhe 48 cm

Tiefe 43 cm

Beschreibung	Breite in cm	Griffe in Chrom			Griffe in Schiefer					
		Art.-Nr.	PG 1 EURO	PG 2 EURO	PG 3 EURO	Art.-Nr.	PG 1 EURO	PG 2 EURO	PG 3 EURO	
<b>Nachtschrank mit einem Auszug, schwebend</b>										
	- Front in Massivholz	Stück	40	<b>102</b>				<b>130</b>		
		Paar	40	<b>103</b>				<b>131</b>		
	- Front Glas weiß	Stück	40	<b>104</b>				<b>132</b>		
		Paar	40	<b>105</b>				<b>133</b>		
	- Front Glas Champagner	Stück	40	<b>106</b>				<b>134</b>		
		Paar	40	<b>107</b>				<b>135</b>		
	- Front Glas mocca	Stück	40	<b>108</b>				<b>136</b>		
		Paar	40	<b>109</b>				<b>137</b>		
<hr/>										
	- Front in Massivholz	Stück	60	<b>120</b>				<b>140</b>		
		Paar	60	<b>121</b>				<b>141</b>		
	- Front Glas weiß	Stück	60	<b>122</b>				<b>142</b>		
		Paar	60	<b>123</b>				<b>143</b>		
	- Front Glas Champagner	Stück	60	<b>124</b>				<b>144</b>		
		Paar	60	<b>125</b>				<b>145</b>		
	- Front Glas mocca	Stück	60	<b>126</b>				<b>146</b>		
		Paar	60	<b>127</b>				<b>147</b>		
<hr/>										



## Nachtschränke, 2 Auszüge schwebend, Höhe 48 cm

Tiefe 43 cm

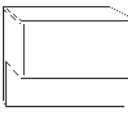
Beschreibung	Breite in cm	Griffe in Chrom			Griffe in Schiefer					
		Art.-Nr.	PG 1 EURO	PG 2 EURO	PG 3 EURO	Art.-Nr.	PG 1 EURO	PG 2 EURO	PG 3 EURO	
<b>Nachtschrank, 2 Auszüge schwebend</b>										
	- Front in Massivholz	Stück	40	<b>150</b>				<b>190</b>		
		Paar	40	<b>151</b>				<b>191</b>		
	- Front Glas weiß	Stück	40	<b>152</b>				<b>192</b>		
		Paar	40	<b>153</b>				<b>193</b>		
	- Front Glas Champagner	Stück	40	<b>154</b>				<b>194</b>		
		Paar	40	<b>155</b>				<b>195</b>		
	- Front Glas mocca	Stück	40	<b>156</b>				<b>196</b>		
		Paar	40	<b>157</b>				<b>197</b>		
	- Front in Massivholz	Stück	60	<b>180</b>				<b>200</b>		
		Paar	60	<b>181</b>				<b>287</b>		
	- Front Glas weiß	Stück	60	<b>182</b>				<b>288</b>		
		Paar	60	<b>183</b>				<b>289</b>		
	- Front Glas Champagner	Stück	60	<b>184</b>				<b>290</b>		
		Paar	60	<b>185</b>				<b>291</b>		
	- Front Glas mocca	Stück	60	<b>186</b>				<b>292</b>		
		Paar	60	<b>187</b>				<b>293</b>		

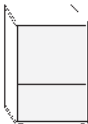
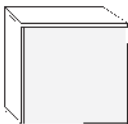

## Nachtschränke, 3 Auszüge, Höhe 48 cm

Tiefe 43 cm

Beschreibung	Breite in cm	Gleitfüße schwarz								
		Art.-Nr.	Griffe in Chrom			Art.-Nr.	Griffe in Schiefer			
			PG 1 EURO	PG 2 EURO	PG 3 EURO		PG 1 EURO	PG 2 EURO	PG 3 EURO	
<b>Nachtschrank, 3 Auszüge</b> Höhe 48 cm										
	- Front in Massivholz	Stück	40	<b>201</b>				<b>300</b>		
		Paar	40	<b>202</b>				<b>301</b>		
	- Front Glas weiß	Stück	40	<b>203</b>				<b>302</b>		
		Paar	40	<b>204</b>				<b>303</b>		
	- Front Glas Champagner	Stück	40	<b>205</b>				<b>304</b>		
		Paar	40	<b>206</b>				<b>305</b>		
	- Front Glas mocca	Stück	40	<b>296</b>				<b>306</b>		
		Paar	40	<b>297</b>				<b>307</b>		
	<hr/>									
		- Front in Massivholz	Stück	60	<b>209</b>				<b>310</b>	
		Paar	60	<b>210</b>				<b>311</b>		
- Front Glas weiß		Stück	60	<b>211</b>				<b>312</b>		
		Paar	60	<b>212</b>				<b>313</b>		
- Front Glas Champagner		Stück	60	<b>213</b>				<b>314</b>		
		Paar	60	<b>214</b>				<b>315</b>		
- Front Glas mocca		Stück	60	<b>298</b>				<b>316</b>		
		Paar	60	<b>299</b>				<b>317</b>		
<hr/>										

## Nachtschränke, 3 Auszüge, Höhe 67 cm

Tiefe 43 cm

Beschreibung	Breite in cm	Kufe in chrom					Kufe in Schiefer				
		Art.-Nr.	Griffe in Chrom			Art.-Nr.	Griffe in Schiefer				
			PG 1 EURO	PG 2 EURO	PG 3 EURO		PG 1 EURO	PG 2 EURO	PG 3 EURO		
<b>Nachtschrank, 3 Auszüge</b> Höhe 67 cm											
	- Front in Massivholz	Stück	40	<b>217</b>				<b>324</b>			
		Paar	40	<b>218</b>				<b>325</b>			
	- Front Glas weiß	Stück	40	<b>219</b>				<b>326</b>			
		Paar	40	<b>220</b>				<b>327</b>			
	- Front Glas Champagner	Stück	40	<b>221</b>				<b>328</b>			
		Paar	40	<b>222</b>				<b>329</b>			
	- Front Glas mocca	Stück	40	<b>320</b>				<b>330</b>			
		Paar	40	<b>321</b>				<b>331</b>			
	<hr/>										
		- Front in Massivholz	Stück	60	<b>225</b>				<b>334</b>		
			Paar	60	<b>226</b>				<b>335</b>		
		- Front Glas weiß	Stück	60	<b>227</b>				<b>336</b>		
		Paar	60	<b>228</b>				<b>337</b>			
- Front Glas Champagner		Stück	60	<b>229</b>				<b>338</b>			
		Paar	60	<b>230</b>				<b>339</b>			
- Front Glas mocca		Stück	60	<b>322</b>				<b>340</b>			
		Paar	60	<b>323</b>				<b>341</b>			
<hr/>											

## Beimöbel

Tiefe: 14 cm    Höhe: 20 cm

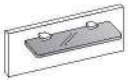
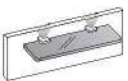
Beschreibung	Breite in cm	Glasbodenhalter in silber			Glasbodenhalter in Schiefer				
		Art.-Nr.	PG 1 EURO	PG 2 EURO	PG 3 EURO	Art.-Nr.	PG 1 EURO	PG 2 EURO	PG 3 EURO
 <p><b>Nachtschrank-Paneel mit Rauchglasboden</b></p>	Stück	40	<b>111</b>			<b>969</b>			
	Paar	40	<b>112</b>			<b>970</b>			
	Stück	60	<b>113</b>			<b>971</b>			
	Paar	60	<b>114</b>			<b>972</b>			
 <p><b>Nachtschrank-Paneel mit Rauchglasboden und LED-Beleuchtung</b></p> <p>Dieses Produkt enthält Lichtquellen der Energieeffizienzklasse G</p>	Stück	40	<b>115</b>			<b>973</b>			
	Paar	40	<b>116</b>			<b>974</b>			
	Stück	60	<b>117</b>			<b>975</b>			
	Paar	60	<b>118</b>			<b>976</b>			



## Beimöbel Höhe 86 cm

Alle Drehtüren inkl. gedämpfter Scharniere

Tiefe 43 cm

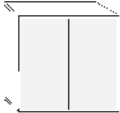
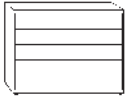
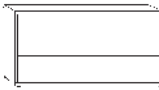
Beschreibung	Breite in cm	Gleitfüße schwarz							
		Art.-Nr.	Griffe in Chrom			Art.-Nr.	Griffe in Schiefer		
			PG 1 EURO	PG 2 EURO	PG 3 EURO		PG 1 EURO	PG 2 EURO	PG 3 EURO
 <p><b>Kommode, 2-türig, mit einem durchgehenden Einlegeboden</b></p> <ul style="list-style-type: none"> <li>- Front in Massivholz</li> <li>- Front Glas weiß</li> <li>- Front Glas Champagner</li> <li>- Front Glas mocca</li> </ul>	80	<b>233</b>				<b>439</b>			
	80	<b>234</b>				<b>481</b>			
	80	<b>235</b>				<b>482</b>			
	80	<b>433</b>				<b>483</b>			
 <p><b>Schubkastenkommode, 5 Auszüge</b></p> <ul style="list-style-type: none"> <li>- Front in Massivholz</li> <li>- Front Glas weiß</li> <li>- Front Glas Champagner</li> <li>- Front Glas mocca</li> </ul>  <ul style="list-style-type: none"> <li>- Front in Massivholz</li> <li>- Front Glas weiß</li> <li>- Front Glas Champagner</li> <li>- Front Glas mocca</li> </ul> <ul style="list-style-type: none"> <li>- Front in Massivholz</li> <li>- Front Glas weiß</li> <li>- Front Glas Champagner</li> <li>- Front Glas mocca</li> </ul> <ul style="list-style-type: none"> <li>- Front in Massivholz</li> <li>- Front Glas weiß</li> <li>- Front Glas Champagner</li> <li>- Front Glas mocca</li> </ul> <ul style="list-style-type: none"> <li>- Front in Massivholz</li> <li>- Front Glas weiß</li> <li>- Front Glas Champagner</li> <li>- Front Glas mocca</li> </ul>	40	<b>244</b>				<b>485</b>			
	40	<b>245</b>				<b>486</b>			
	40	<b>246</b>				<b>487</b>			
	40	<b>434</b>				<b>488</b>			
	60	<b>248</b>				<b>490</b>			
	60	<b>249</b>				<b>491</b>			
	60	<b>250</b>				<b>492</b>			
	60	<b>435</b>				<b>493</b>			
	80	<b>252</b>				<b>495</b>			
	80	<b>253</b>				<b>496</b>			
	80	<b>254</b>				<b>497</b>			
	80	<b>436</b>				<b>498</b>			
	141	<b>256</b>				<b>500</b>			
	141	<b>257</b>				<b>501</b>			
	141	<b>258</b>				<b>502</b>			
	141	<b>437</b>				<b>503</b>			

## Zubehör für Beimöbel

Beschreibung	Maße in cm			Art.-Nr.	EURO
	B	H	T		
 <p><b>1 Einlegeboden</b> für 2-türige Kommode</p>	77	1,8	37,5	<b>034</b>	

## Beimöbel Höhe 86 cm

Alle Drehtüren inkl. gedämpfter Scharniere

Tiefe 43 cm

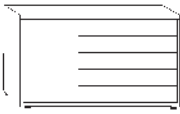
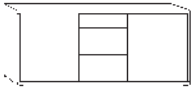
Beschreibung	Breite in cm	Gleitfüße schwarz							
		Art.-Nr.	Griffe in Chrom			Art.-Nr.	Griffe in Schiefer		
PG 1 EURO	PG 2 EURO		PG 3 EURO	PG 1 EURO	PG 2 EURO		PG 3 EURO		
 <p><b>Kombikommode, mit 5 Auszügen rechts, links eine Tür mit einem Einlegeboden</b></p> <ul style="list-style-type: none"> <li>- Front in Massivholz</li> <li>- Front Glas weiß</li> <li>- Front Glas Champagner</li> <li>- Front Glas mocca</li> </ul>	120	<b>549</b>				<b>561</b>			
	120	<b>550</b>				<b>562</b>			
	120	<b>551</b>				<b>563</b>			
	120	<b>552</b>				<b>564</b>			
<p>Tür massiv, Auszüge in</p> <ul style="list-style-type: none"> <li>- Glas weiß</li> <li>- Glas Champagner</li> <li>- Glas mocca</li> </ul>	120	<b>554</b>				<b>566</b>			
	120	<b>555</b>				<b>567</b>			
	120	<b>556</b>				<b>568</b>			
 <p><b>Kombikommode, 5 Auszüge mittig, 2 Türen außen, je Türenfach 1 Einlegeboden</b></p> <ul style="list-style-type: none"> <li>- Front in Massivholz</li> <li>- Front Glas weiß</li> <li>- Front Glas Champagner</li> <li>- Front Glas mocca</li> </ul> <p>Türen in Massivholz</p> <ul style="list-style-type: none"> <li>- Auszüge Glas weiß</li> <li>- Auszüge Glas Champagner</li> <li>- Auszüge Glas mocca</li> </ul>	141	<b>237</b>				<b>571</b>			
	141	<b>238</b>				<b>572</b>			
	141	<b>239</b>				<b>573</b>			
	141	<b>559</b>				<b>574</b>			
	141	<b>241</b>				<b>576</b>			
	141	<b>242</b>				<b>577</b>			
	141	<b>560</b>				<b>578</b>			



## Zubehör für Beimöbel

Beschreibung	Maße in cm			Art.-Nr.	EURO
	B	H	T		
 <p><b>1 Einlegeboden</b> für Kombikommode</p>	37	1,8	37,5	<b>035</b>	

## Beimöbel Höhe 105 cm

Alle Drehtüren inkl. gedämpfter Scharniere

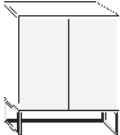
Tiefe 43 cm

Beschreibung	Breite in cm	Kufe in chrom			Kufe in Schiefer				
		Art.-Nr.	Griffe in Chrom PG 1 EURO	PG 2 EURO	PG 3 EURO	Art.-Nr.	Griffe in Schiefer PG 1 EURO	PG 2 EURO	PG 3 EURO
 <p><b>Kommode, 2-türig , mit einem durchgehenden Einlegeboden</b></p> <ul style="list-style-type: none"> <li>- Front in Massivholz</li> <li>- Front Glas weiß</li> <li>- Front Glas Champagner</li> <li>- Front Glas mocca</li> </ul>	80	<b>260</b>				<b>585</b>			
	80	<b>261</b>				<b>586</b>			
	80	<b>262</b>				<b>587</b>			
	80	<b>580</b>				<b>588</b>			
 <p><b>Schubkastenkommode, 5 Auszüge</b></p> <ul style="list-style-type: none"> <li>- Front in Massivholz</li> <li>- Front Glas weiß</li> <li>- Front Glas Champagner</li> <li>- Front Glas mocca</li> <li>- Front in Massivholz</li> <li>- Front Glas weiß</li> <li>- Front Glas Champagner</li> <li>- Front Glas mocca</li> <li>- Front in Massivholz</li> <li>- Front Glas weiß</li> <li>- Front Glas Champagner</li> <li>- Front Glas mocca</li> </ul>	40	<b>271</b>				<b>590</b>			
	40	<b>272</b>				<b>591</b>			
	40	<b>273</b>				<b>592</b>			
	40	<b>581</b>				<b>593</b>			
	60	<b>275</b>				<b>595</b>			
	60	<b>276</b>				<b>596</b>			
	60	<b>277</b>				<b>597</b>			
	60	<b>582</b>				<b>598</b>			
	80	<b>279</b>				<b>713</b>			
	80	<b>280</b>				<b>714</b>			
	80	<b>281</b>				<b>715</b>			
	80	<b>583</b>				<b>716</b>			
 <ul style="list-style-type: none"> <li>- Front in Massivholz</li> <li>- Front Glas weiß</li> <li>- Front Glas Champagner</li> <li>- Front Glas mocca</li> </ul>	141	<b>283</b>				<b>718</b>			
	141	<b>284</b>				<b>719</b>			
	141	<b>285</b>				<b>720</b>			
	141	<b>584</b>				<b>721</b>			

## Zubehör für Beimöbel

Beschreibung	Maße in cm			Art.-Nr.	EURO
	B	H	T		
 <p><b>1 Einlegeboden</b> für 2-türige Kommode</p>	77	1,8	37,5	<b>034</b>	

## Beimöbel Höhe 105 cm

Alle Drehtüren inkl. gedämpfter Scharniere

Tiefe 43 cm

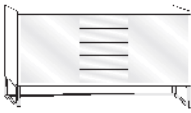



Beschreibung	Breite in cm	Kufe in chrom			Kufe in Schiefer					
		Art.-Nr.	Griffe in Chrom PG 1 EURO	PG 2 EURO	PG 3 EURO	Art.-Nr.	Griffe in Schiefer PG 1 EURO	PG 2 EURO	PG 3 EURO	
 <p><b>Kombikommode, mit 5 Auszügen rechts, links eine Tür mit einem Einlegeboden</b></p> <ul style="list-style-type: none"> <li>- Front in Massivholz</li> <li>- Front Glas weiß</li> <li>- Front Glas Champagner</li> <li>- Front Glas mocca</li> </ul>	120	<b>723</b>				<b>734</b>				
	120	<b>724</b>				<b>735</b>				
	120	<b>725</b>				<b>736</b>				
	120	<b>726</b>				<b>737</b>				
<p>Tür massiv, Auszüge in</p> <ul style="list-style-type: none"> <li>- Glas weiß</li> <li>- Glas Champagner</li> <li>- Glas mocca</li> </ul>	120	<b>728</b>				<b>739</b>				
	120	<b>729</b>				<b>740</b>				
	120	<b>730</b>				<b>741</b>				
 <p><b>Kombikommode, 5 Auszüge mittig, 2 Türen außen, je Türenfach 1 Einlegeboden</b></p> <ul style="list-style-type: none"> <li>- Front in Massivholz</li> <li>- Front Glas weiß</li> <li>- Front Glas Champagner</li> <li>- Front Glas mocca</li> </ul> <p>Türen in Massivholz</p> <ul style="list-style-type: none"> <li>- Auszüge Glas weiß</li> <li>- Auszüge Glas Champagner</li> <li>- Auszüge Glas mocca</li> </ul>	141	<b>264</b>				<b>743</b>				
	141	<b>265</b>				<b>744</b>				
	141	<b>266</b>				<b>745</b>				
	141	<b>732</b>				<b>746</b>				
	141	<b>268</b>				<b>748</b>				
	141	<b>269</b>				<b>749</b>				
	141	<b>733</b>				<b>750</b>				

## Zubehör für Beimöbel

Beschreibung	Maße in cm			Art.-Nr.	EURO
	B	H	T		
 <p><b>1 Einlegeboden</b> für Kombikommode</p>	37	1,8	37,5	<b>035</b>	



## Beimöbel

Beschreibung	Maße in cm			Art.-Nr.	PG 1 EURO	PG 2 EURO	PG 3 EURO
	B	H	T				
 <p><b>Steckböden massiv</b></p>							
	40	3	20	<b>082</b>			
	60	3	20	<b>083</b>			
	80	3	20	<b>084</b>			
 <p><b>Ankleidebank massiv mit Polster</b></p> <ul style="list-style-type: none"> <li>- in Kunstleder weiß</li> <li>- in Kunstleder Champagner</li> <li>- in Kunstleder mocca</li> </ul>							
	120	46,3	40	<b>752</b>			
	120	46,3	40	<b>753</b>			
	120	46,3	40	<b>754</b>			
 <p><b>Wandspiegel, Parsol-Bronze-Glas mit Facette</b></p>							
	60	80	3	<b>088</b>			
 <p><b>Wandspiegel, Parsol-Bronze-Glas mit Facette</b></p>							
	110	85	3	<b>650</b>			

## Beimöbel

Tiefe 30 cm, Höhe 123 cm

Beschreibung	Breite in cm	Griffe in Chrom			Griffe in Schiefer				
		Art.-Nr.	PG 1 EURO	PG 2 EURO	PG 3 EURO	Art.-Nr.	PG 1 EURO	PG 2 EURO	PG 3 EURO
 <b>Hängeschrank mit Tür</b>  Paar Stück, links ang. Stück, rechts ang.	40	<b>085</b>				<b>987</b>			
	40	<b>086</b>				<b>988</b>			
	40	<b>087</b>				<b>989</b>			

## Beimöbel

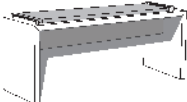
Beschreibung	Maße in cm		Griffe in Chrom		Griffe in Schiefer	
	B	T	Art.-Nr.	EURO	Art.-Nr.	EURO
 <p><b>Ankleidebank</b> in Holz-Nachbildung mit Polster</p> <ul style="list-style-type: none"> <li>- in Kunstleder weiß</li> <li>- in Kunstleder Champagner</li> <li>- in Kunstleder mocca</li> </ul>						
	120	40	<b>756</b>		<b>977</b>	
	120	40	<b>757</b>		<b>978</b>	
	120	40	<b>758</b>		<b>979</b>	